

Geuder®

OPHTHALMIC SURGICAL PRODUCTS

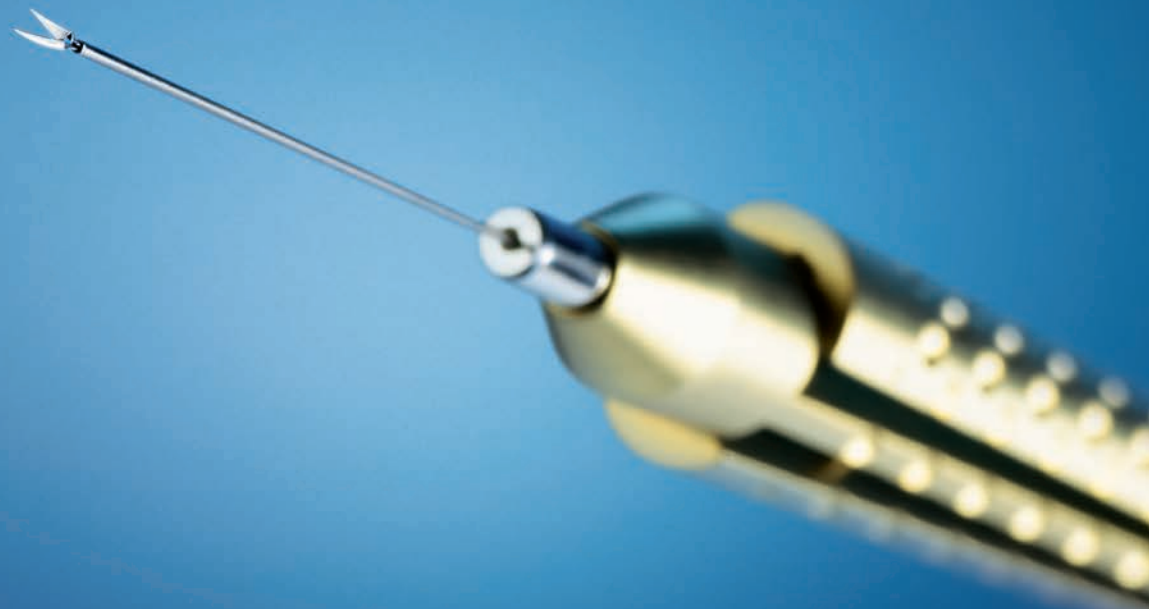

Geuder®
Precision made in Germany

INSTRUMENTS

MAIN CATALOGUE

06 / 2018

FOCUSED ON PRECISION.

GEUDER - PRECISION MADE IN GERMANY.

GEUDER AG was founded by Hans Geuder Sr. in Heidelberg 1951, since then it has become a worldwide leading manufacturer of ophthalmic surgical instruments and systems as well as provider for highly purified biomaterials. The broad portfolio offered by GEUDER AG includes a wide range of surgical equipment for the anterior and posterior segments of the eye, along with highly innovative biomaterials for retinal and cataract surgery developed and produced by our affiliated company FLUORON GmbH.

As a result of intensive contact and cooperations with leading experts in the ophthalmology world, GEUDER AG is continuously developing and

manufacturing the most innovative products that fulfill the international standards.

A numerous amount of granted patents in more than 65 years demonstrates our intensive involvement in research and development, as well as our forward-looking philosophy. Always keeping our goal to provide the highest level of precision and reliability while complying with the requirements of ophthalmologists to serve the patient's expectations and well being.

With over 3.000 ophthalmic surgical products being distributed in more than 100 countries, GEUDER AG covers a large range of instruments



required for surgical procedures in the anterior and posterior segment of the eye. Thanks to innovative production technologies our instruments offer a unique level of precision and longevity. The constant extension of our product range – particularly single-use instruments – is following the current and especially prospective regulatory requirements and statutory regulations in the medical sector.

Qualified and specialized employees in the field of service and repair ensure that the product's performance and quality is maintained over years – an important feature for the ophthalmic surgeon who is aware of quality and environment.

Our catalogue, in addition to classic standard instruments also displays the most representative current instruments as well as novelties and new developments for innovative surgical methods.

Please contact us for more detailed information about our surgical instruments, systems and biomaterials.

Certified to ISO 9001/13485



	EYE SPECULA	01
	RETRACTORS	02
CALIPERS · MARKERS · MEASURING INSTRUMENTS · TONOMETER · OCULOPRESSOR		03
	CURETTES · SPOONS	04
	FOREIGN BODY INSTRUMENTS	05
	KNIVES · DIAMOND KNIVES	06
	TREPHINES	07
	GLAUCOMA PUNCHES · RONGEURS	08
	SCISSORS	09
	FORCEPS	10
	NEEDLE HOLDERS	11
MANIPULATORS · CHOPPERS · FIXATION RINGS · HOOKS · SPATULAS · LENS LOOPS		12
	SCLERAL DEPRESSORS · LOCALIZERS	13
	PROBES · DILATORS	14
	CANNULAS · I/A INSTRUMENTS	15
	SINGLE USE INSTRUMENTS	16
	MISCELLANEOUS	17
	STERILIZATION CONTAINERS AND ADAPTERS	18
	SETS	19
	INDEX	IN

01.	EYE SPECULA	13
	Wire	15 – 17
	Wire · Adjustable	18 – 19
	Adjustable · Locking	20 – 26
	Aspiration · Adjustable · Locking	27 – 30
	Glaucoma · Adjustable	31
	Glaucoma · Adjustable · Aspiration	32
02.	RETRACTORS	33
	Lid	35 – 36
	Lacrimal Sac	37 – 38
	Adjustable	38
03.	CALIPERS · MARKERS · MEASURING INSTRUMENTS	
	TONOMETER · OCULOPRESSOR	39
	Corneal Markers	41 – 42
	Muscle Tucker	42
	Calipers	43
	Rulers	43 – 44
	Trabeculectomy Marker · Strabismus Marker	44
	LASIK Markers · Keratometer	45
	Degree Gauges · Axis Markers	46
	Toric Markers	47
	Tonometer · Oculopressor	48
04.	CURETTES · SPOONS	49
	Chalazion	51 – 52
	Enucleation	52
05.	FOREIGN BODY INSTRUMENTS	53
	Foreign Body Spuds · Needles · Gouges	55 – 56
06.	KNIVES · DIAMOND KNIVES	57
	Diamond Knives: Paracentesis · Sideport · Universal	59
	Diamond Knives: Tri-Facet · Clear Cornea · Trapezoid · Phaco	60
	Diamond Knives: Clear Cornea · Crescent · Step Knife · LRI	61
	Diamond Knives: Micrometers · Viscocanalostomy · Retinal Surgery	62
	Keratome · Chalazion · Viscocanalostomy · Scleral	63
	Corneal Scarifier · DMEK Scraper	64
	SATO	65
	CRVO	66

07.	TREPHINES	67
	Trephines.....	69 – 70
	Punch.....	70
	Silicone Blocks.....	71 – 72
08.	GLAUCOMA PUNCHES · RONGEURS	73
	Rongeurs.....	75
	Glaucoma Punches.....	76 – 77
09.	SCISSORS	79
	Corneal · Corneal Section.....	81 – 82
	Stitch.....	82
	Synechia · Trabeculum.....	83
	Capsulotomy.....	83 – 85
	Capsule.....	84 – 86
	Capsulotomy · Rotatable · Interchangeable.....	85
	Capsule (Interchangeable and Rotatable).....	86
	Iris.....	86 – 87
	IOL.....	87 – 88
	Scissors with Needle Holder.....	88
	Tenotomy · Conjunctival · Ring Handle.....	89
	Tenotomy · Strabismus · Ring Handle.....	90
	Utility · Ring Handle.....	91
	Utility · Stitch · Ring Handle.....	92
	Utility · Probe Tips · Ring Handle.....	93
	Utility · Enucleation · Ring Handle.....	94
	Vitreoretinal 20 Gauge.....	95
	Vitreoretinal 23 & 25 Gauge.....	96
	Vitreoretinal (Interchangeable and Rotatable).....	97
10.	FORCEPS	99
	Cilia · Foreign Body.....	101
	Conjunctiva.....	102
	Suturing · Fixation.....	103
	Suturing · Colibri Style.....	104
	Corneal Fixation.....	104 – 105
	<i>PAUFIQUE</i> Suturing/Tying.....	105
	Tying.....	106 – 108
	Iris suture · Fragment.....	108
	Jewelers · Fixation.....	109
	Dressing · Tissue.....	110

Iris Fixation	110 – 112
Capsulorhexis	113 – 117
Capsulorhexis · Micro Incision	115
Capsulorhexis · Micro Incision · Interchangeable	116
Capsulorhexis · DMEK · Descemetorhexis.....	117
DSAEK.....	118
LASIK Flap	118 – 119
Lenticule Extraction	119
Nucleus Cracker	120
Nucleus Prechoppers	120 – 121
IOL Implantation.....	121
IOL Implantation · Silicone Coated.....	122
IOL Implantation · Iris Claw.....	123
IOL Folders	123 – 124
IOL Holders.....	124
IOL Explantation	125
Superior Rectus	126
Muscle	126 – 127
Nasal · Retinal.....	127
Retinal (Scleral Plug, Retinal Tack)	128
Vitreoretinal (Spreading, Trocar, Foreign Body, Magnet).....	129
Vitreoretinal 20 Gauge	130 – 131
Vitreoretinal 23 & 25 Gauge.....	132
Vitreoretinal · Interchangeable · Rotatable	133
Chalazion · Ptosis	134
Mosquito · Hemostat.....	135
Towel Clamps · Serrefines	136
11. NEEDLE HOLDERS	137
Needle Holders.....	139 – 144
Needle Holder with Scissors · Intraocular 25 Gauge	143
Blade Holders	145
12. MANIPULATORS · CHOPPERS · FIXATION RINGS	
HOOKS · SPATULAS · LENS LOOPS.....	147
Fixation Rings	149 – 150
Nucleus Choppers	151 – 154
Manipulators	153 – 154
Nucleus Manipulators	155
IOL Manipulators	155 – 157
Position Hooks.....	156 – 157
Iris Hooks	157 – 158

	Nucleus Fragmentation Spatulas	158
	Phaco Spatulas	159
	Capsule Polishers.....	160
	Lens Loops	161
	Orbital Spatulas	162
	Keratoplasty · Synechia Spatulas	163
	Cyclodialysis Spatulas	164
	Iris Spatulas	165 – 166
	Enucleation	167
	LASIK Spatulas	167 – 168
	DMEK Hooks · DSAEK Glide	168
	Femtosecond Cataract.....	169
	Femtosecond LASIK.....	169 – 172
	Strabismus Muscle Tucker	172
	Strabismus Hooks.....	173 – 174
	Retinal Detachment Hook.....	174
	Membrane Spatulas · Membrane Peelers	175
13.	SCLERAL DEPRESSORS · LOCALIZERS	177
	Scleral Depressors.....	179 – 180
	Localizers.....	180
14.	PROBES · DILATORS	181
	Lacrimal Probes	183 – 186
	Corneal Implant Probes	184
	Trabecular Probes · U-Shaped Probe.....	186
15.	CANNULAS · I/A INSTRUMENTS	187
	Lacrimal.....	189 – 190
	Lacrimal Probes.....	190
	Retrobulbar · Eye Douche · A.C. Maintainers · Cystotome · Enzyme	191
	Hydrodissection · Cyclodialysis	192
	Irrigation Vectis · Healon · Trabeculotomy · Sub-Tenon	193
	Irrigation	194
	Irrigation/Aspiration.....	194 – 195
	Capsule Polishers.....	195 – 196
	LASIK	196 – 197
	Irrigation Cannula Handpieces.....	197
	I/A Handpieces · Bimanual	198
	Bimanual Irrigation/Aspiration.....	199 – 201
	Irrigation Choppers · Irrigation Hook · Irrigation Scraper	202
	Coaxial Irrigation/Aspiration.....	203 – 205

	DMEK Irrigation.....	203
	Coaxial Irrigation/Aspiration.....	204
	Retinal · Backflush Handpieces.....	206
	Retinal · Backflush Cannulas.....	207
	Retinal · Backflush Tips.....	208
	Retinal · Infusion/Injection Cannulas.....	209
	Retinal · Infusion · Aspiration · PFCL.....	210
	Retinal.....	211
	Miscellaneous.....	212
16.	SINGLE USE INSTRUMENTS.....	213
	Manual Trephines · Cutting Block · Non-Vacuum Punches.....	215
	Vacuum Trephines & Punches.....	216
	Surgical Knives.....	217
	Scissors.....	218
	Forceps.....	219
	Endo Probes.....	220
	Trocars.....	221
	Fibre Optics.....	221 – 222
	Vitreous Cutters · Infusion Tube.....	222
	Speculum · DMEK Cartridge · Iris Retractors · Lacrimal Intubation.....	223
	Intubation Sets · Cannulas (Lacrimal, Retrobulbar, Cystotome).....	224
	Cannulas (A.C. Maintainer, Rycroft, Hydrodissection).....	225
	Cannulas (Irrigation Vectis, Capsule Polisher, Simcoe, Viscocanalostomy, Irrigation).....	226
	Bimanual I/A Handpiece · Backflush Handpiece · Backflush Cannula · Silicone Brush.....	227
	Cannulas (Backflush with Silicone Tip, PFCL, Silicone Oil, Infusion).....	228
	Cannulas (Injection, Viscous Fluids, Gas).....	229
	Oil Injection.....	230
	Stopcock · Scalpel Blades · Absorbent Swabs · Marking Pen.....	231
	Silicone Tires.....	232
	Silicone Bands.....	233
	Silicone Strips.....	234
	Silicone Sleeves.....	234 – 235
	Silicone Wedge.....	235
	Silicone Sponge Implants.....	235 – 238
	Bonn Injection Set.....	238
17.	MISCELLANEOUS.....	239
	Injectors (for <i>MORCHER</i> Capsular Tension Ring and Pupil Dilators).....	241
	Lacrimal Instruments · Rongeur · Nasal Speculum · Hammer · Elevatorium · Raspatorium.....	242
	Bone Chisels · LASEK Funnel · Fascia Needle.....	243

	Diamond Burr · Vitrectomy Lenses	244
	Eye Shield · Eye Spheres.....	245
	Battery Cautery · Intraocular Magnet.....	246
18.	STERILIZATION CONTAINERS AND ADAPTERS.....	247
	MICROSTOP®	249 – 251
	Steel Cases.....	252 – 255
	Trays & Racks for Steel Cases	256
	Silicone Strips & Silicone Mats.....	257
	Seals · Small Cases.....	258
	STERISAFE® DURO	259 – 262
	STERISAFE® DURO · Melag.....	263
	Adapters	264 – 266
19.	SETS	S1
	ECCE – Extra Capsular Cataract Extraction.....	S2
	Phaco / Cataract.....	S3
	Phaco Emergency / MSICS – Manual Small Incision Cataract Surgery.....	S4
	MICS – Micro Incision Cataract Surgery / FLACS – Femtosecond Laser-assisted Cataract Surgery	S5
	Snyder-Osher IOL Explanation · Toric IOL · Hattenbach Iris suture	S6
	LASEK · LASIK.....	S7
	Femto LASIK · ReLex SMILE.....	S8
	Keratoplasty	S9
	DSEK / DSAEK · DALK.....	S10
	DMEK.....	S11
	Glaucoma.....	S12
	Emergency	S13
	Enucleation · Pterygium	S14
	Office set (Optometrist) · Chalazion	S15
	Lid / Ptosis	S16
	DCR / Lacrimal.....	S17
	Strabismus / Muscle.....	S18
	Retinal Detachment	S19
	Vitrectomy 20G	S20 – S21
	Vitrectomy 23G	S22 – S23
	Vitrectomy 25G	S24
20.	INDEX.....	I1
	Numerical Index.....	I2 – I9
	Keyword Index	I10 – I17
	Name Index	I18 – I20

© GEUDER AG

Although every effort has been made to ensure the accuracy of the content presented in this catalogue, GEUDER AG cannot be held liable for any errors that may occur.

Due to the constant technological progress all product specifications and illustrations are subject to change without notice.

No part of this catalogue may be reproduced, edited, copied or disseminated in any form (analog or digital) without prior written consent of GEUDER AG.

All rights reserved by GEUDER AG, Heidelberg, Germany.
Any violation of the copyright will be prosecuted.

Edition 06/2018

© GEUDER AG

Manufacturer of ophthalmic surgical instruments and systems

Some Geuder products may not be available for sale in certain countries where the products have not yet received investigational, clinical or marketing approval. Please contact your local distributor or GEUDER AG for more information.

GEUDER AG
Hertzstr. 4
69126 Heidelberg
Germany

Phone: +49 6221 306-6
Fax: +49 6221 303122
info@geuder.de
www.geuder.de

„NanoEdge®“, „UNO Colorline®“, „Densiron®“, „Megatron®“, „endoTRON®“ and „MACH2“ are registered trademarks of Geuder AG.

„EasyGas®“ is a registered trademark of Fluoron GmbH.

„Sterisafe®“ is a registered trademark of SAVUNA GmbH & Co. KG.

„microStop®“ is a registered trademark of Gebrüder Martin GmbH & Co. KG.

„ReLEx® Smile“ and „SMILE“ are registered trademarks of Carl Zeiss Meditec AG.

„IRIDEX®“ is a registered trademark of IRIDEX Corporation.

„ACCURUS®“ is a registered trademark of Alcon Laboratories, Inc.

„Pentasy®“ is a registered trademark of Fritz RUCK Ophthalmologische Systeme GmbH.

„Millennium®“ is a registered trademark of MBI Millennium Biomedical, Inc.

EYE SPECULA

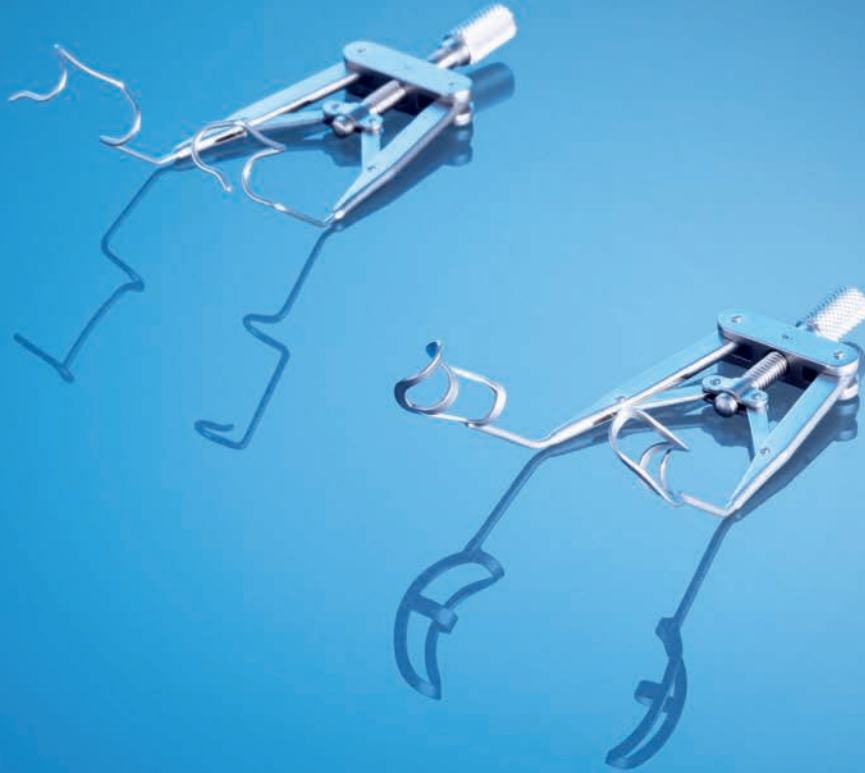

WIRE	15
WIRE AND ADJUSTABLE	18
ADJUSTABLE / LOCKING	20
WITH ASPIRATION	27
ADJUSTABLE / BLADE ELEVATION	31

G-17020 *BARRAQUER*
EYE SPECULUM
fenestrated
14 mm blades
overall length 38 mm

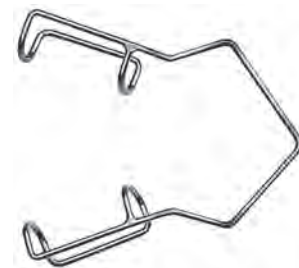

G-17025 *BARRAQUER*
EYE SPECULUM
for infants
fenestrated
10 mm blades
overall length 40 mm



G-17023 *BARRAQUER*
EYE SPECULUM
for premature infants
fenestrated
7 mm blades
overall length 34 mm

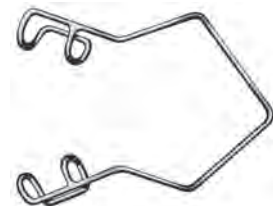

G-17026 *BARRAQUER*
EYE SPECULUM
15 mm solid blades
overall length 40 mm

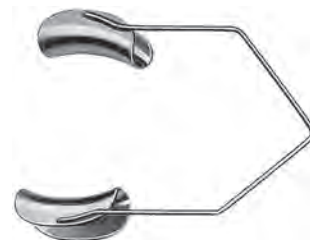

01

WIRE

01

WIRE

G-32136

BARRAQUER
EYE SPECULUM
 fenestrated
 14 mm round blades
 overall length 38 mm

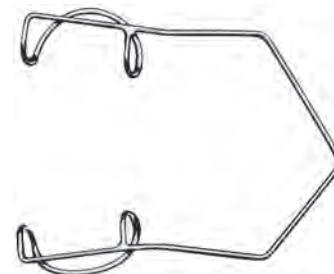

G-32137

BARRAQUER
EYE SPECULUM
 for infants
 fenestrated
 10 mm round blades
 overall length 38 mm

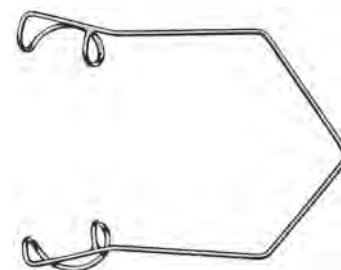

G-32148

BARRAQUER
EYE SPECULUM
 fenestrated
 14.5 mm open blades
 overall length 40 mm

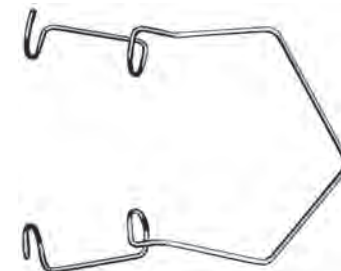

G-32149

BARRAQUER FRANKFURT MODEL
EYE SPECULUM
 fenestrated, large
 14.5 mm blades
 overall length 40 mm

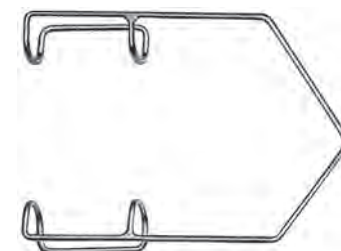

G-32133

*KRATZ-BARRAQUER***EYE SPECULUM**

fenestrated

15 mm round wing blades

overall length 40 mm

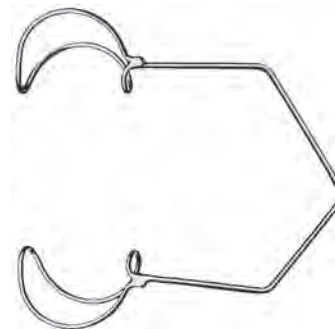
to lift and retract the lids away from the globe
eliminating external pressure

01

WIRE

*OHNO***EYE SPECULUM**

fenestrated

14 mm round blades

overall length 45 mm

middle bar controls redundant lid tissue

G-32126

for the right eye

G-32127

for the left eye

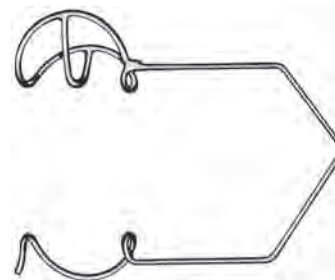

G-17004

*H.-R. KOCH***TEMPORAL APPROACH EYE SPECULUM**

for nasal placement

fenestrated

14 mm open blades

overall length 40 mm

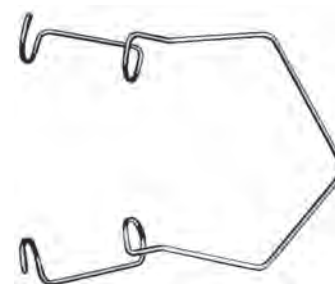

G-32129

TEMPORAL APPROACH EYE SPECULUM

for nasal placement

fenestrated

15 mm round blades

overall length 40 mm

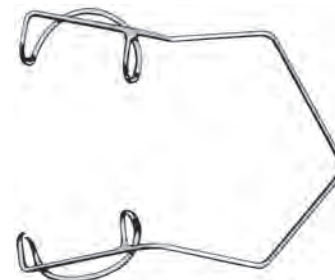

01

WIRE · ADJUSTABLE

BARRAQUER-OOSTERHUIS

EYE SPECULUM

fenestrated, adjustable

G-17010

14 mm blades, overall length 40 mm

G-17011

10 mm blades, overall length 30 mm, for infants

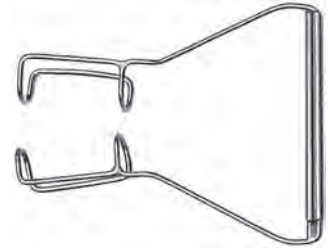

BARRAQUER-OOSTERHUIS

EYE SPECULUM

solid blades, adjustable

G-17015

15 mm blades, overall length 40 mm

G-17016

11 mm blades, overall length 30 mm, for infants

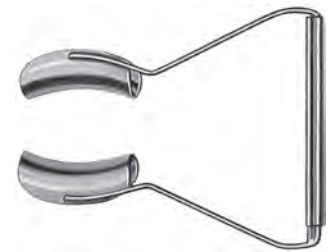

BARRAQUER-OOSTERHUIS

EYE SPECULUM

fenestrated round blades

adjustable

G-32138

14 mm blades, overall length 40 mm

G-32139

11 mm blades, overall length 30 mm, for infants

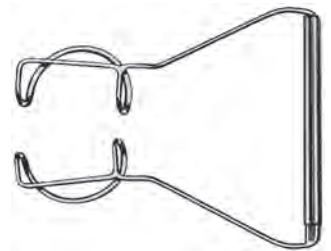

G-17017

BARRAQUER-OOSTERHUIS-KRATZ

EYE SPECULUM

adjustable, fenestrated

15 mm open blades

overall length 40 mm

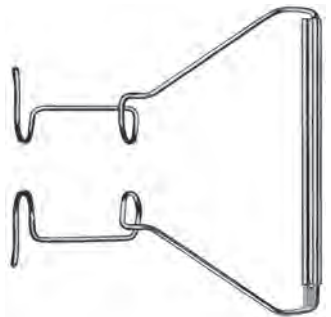

- G-32119** *KRATZ-BARRAQUER*
EYE SPECULUM
adjustable, fenestrated
15 mm round wing blades
overall length 40 mm

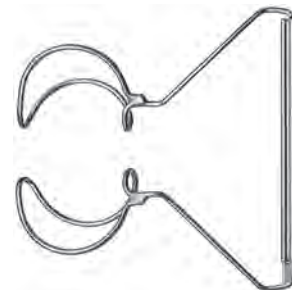

01

WIRE · ADJUSTABLE

- G-17027** *THOMAS NEUHANN*
EYE SPECULUM
adjustable
15 mm solid blades
overall length 40 mm

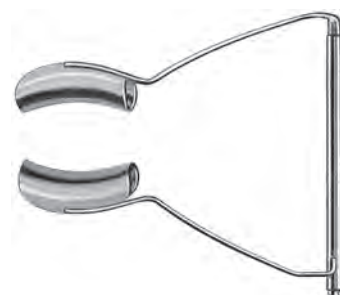

- G-17030** *SAUER*
EYE SPECULUM
12 mm solid blades
overall length 30 mm



- G-32134** *TAKEDA*
EYE SPECULUM
for infants
9 mm fenestrated blades
with finger grips and
angled interlacing valves
overall length 28 mm



G-15945

MELLINGER
EYE SPECULUM

large
adjustable, self retaining
16.5 mm fenestrated blades
overall length 65 mm

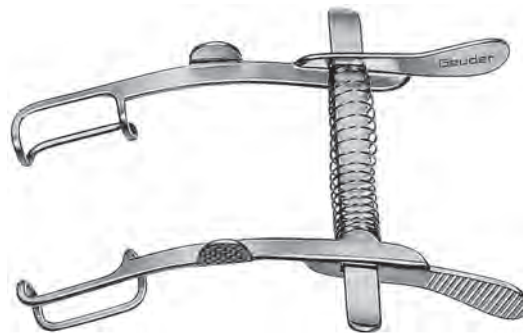

G-32130

MELLINGER
EYE SPECULUM

small, for infants
adjustable, self retaining
12.5 mm fenestrated blades
overall length 55 mm

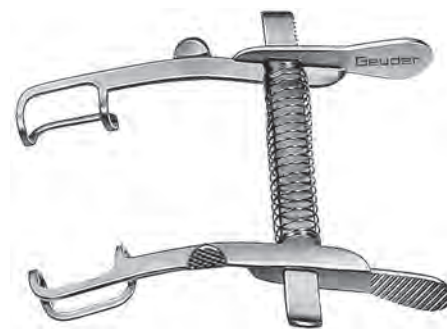

G-15946

MELLINGER-BEARD
EYE SPECULUM

large
adjustable, self retaining
15.5 mm solid blades
overall length 65 mm

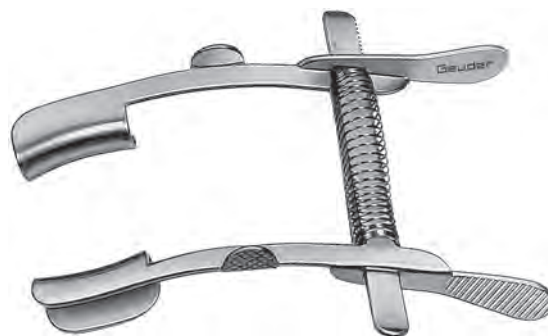

G-32135

MELLINGER-BEARD
EYE SPECULUM

small, for infants
adjustable, self retaining
11.5 mm solid blades
overall length 55 mm

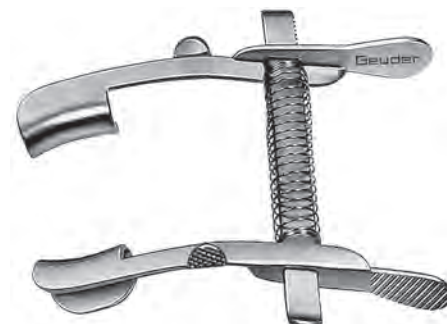

*PRETORI***EYE SPECULUM**

13.5 mm fenestrated blades
adjustable, self retaining
overall length 63 mm
left
right

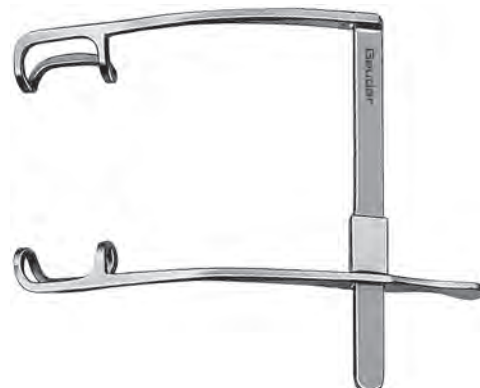
G-16050**G-16055****01**

ADJUSTABLE · LOCKING

G-15950*WEISS***EYE SPECULUM**

fenestrated
adjustable with locking screw
17.5 mm blades
overall length 85 mm

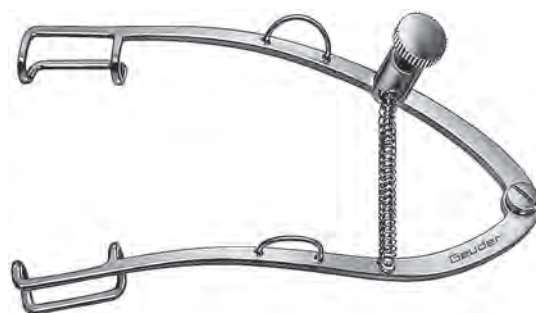
**G-15951***WEISS***EYE SPECULUM**

fenestrated
adjustable with locking screw
17.5 mm open blades
overall length 85 mm

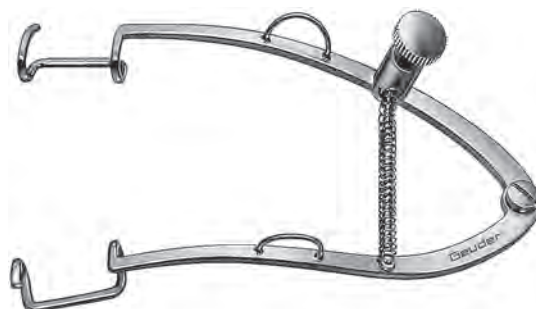
**G-15955***WEISS***EYE SPECULUM**

small
adjustable with locking screw
15 mm fenestrated blades
overall length 55 mm



G-15956

WEISS
EYE SPECULUM

small
adjustable with locking screw
15 mm open blades
overall length 55 mm



G-15970

WEISS
EYE SPECULUM

adjustable with locking screw
16.5 mm solid blades
overall length 85 mm



G-15975

WEISS
EYE SPECULUM

small
adjustable with locking screw
14 mm solid blades
overall length 55 mm

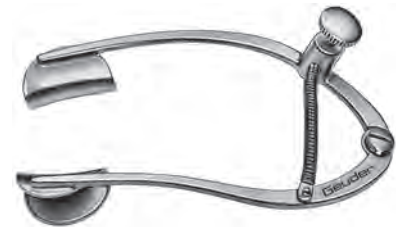

G-37130

BARTL
EYE SPECULUM

adjustable
with silicone band to secure vitrectomy lens
15 mm solid blades
overall length 39 mm

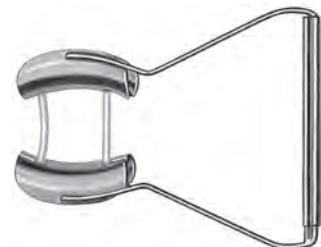

- G-16010** *BANGERTER*
EYE SPECULUM
adjustable, with locking screw
15 mm solid blades
overall length 52 mm

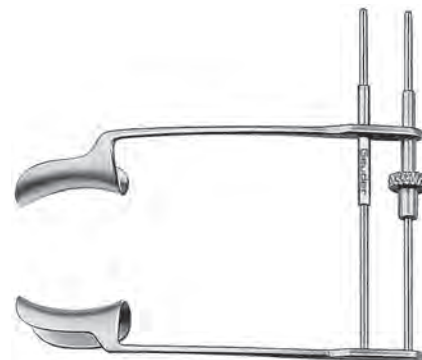

- CASTROVIEJO*
EYE SPECULUM
fenestrated, adjustable
overall length 96 mm
G-16020 14 mm blades, small
G-16025 16 mm blades, medium
G-16030 18 mm blades, large



- G-15990** *COOK*
EYE SPECULUM
large
16 mm solid blades
adjustable, with locking screw
overall length 50 mm

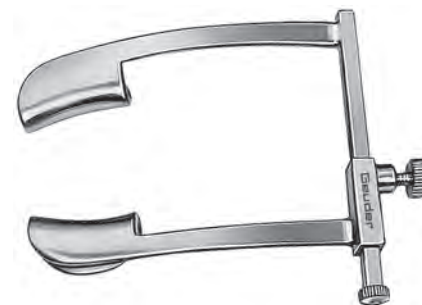

- G-15995** *COOK*
EYE SPECULUM
medium
11 mm solid blades
adjustable, with locking screw
overall length 40 mm



01

ADJUSTABLE · LOCKING

01

ADJUSTABLE · LOCKING

G-16000

COOK
EYE SPECULUM

small
8 mm solid blades
adjustable, with locking screw
overall length 35 mm



G-32128

COOK
EYE SPECULUM

for infants
5 mm solid blades
adjustable, with locking screw
overall length 30 mm



G-17000

MURDOCK
EYE SPECULUM

left
14 mm fenestrated blades
adjustable, self retaining
overall length 50 mm

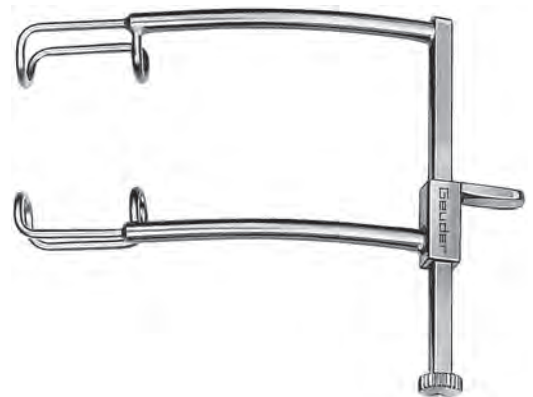

G-17001

MURDOCK
EYE SPECULUM

right
14 mm fenestrated blades
adjustable, self retaining
overall length 50 mm

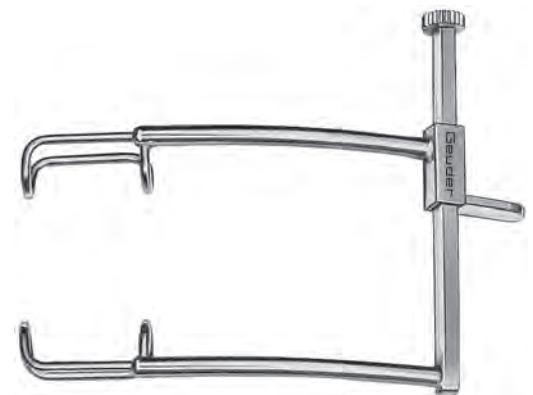

MURDOCK
EYE SPECULUM

small
12 mm fenestrated blades
adjustable, self retaining
overall length 45 mm
left
right

G-17002
G-17003

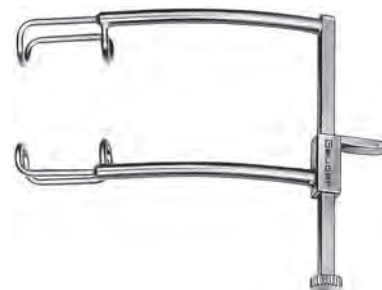

01

ADJUSTABLE · LOCKING

G-15960*LIEBERMANN-TENNANT*
EYE SPECULUM

adjustable, fenestrated
for temporal placement
15 mm open blades
overall length 80 mm

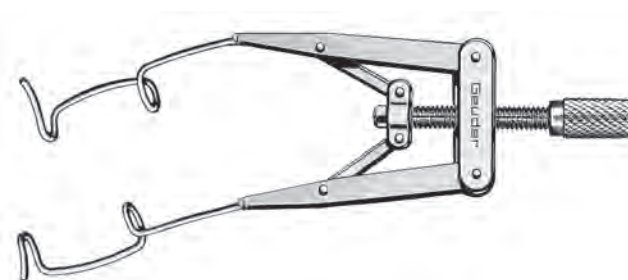
**G-15965***KERSHNER*
EYE SPECULUM

adjustable, reversible
for nasal and temporal placement
15 mm fenestrated blades
overall length 75 mm

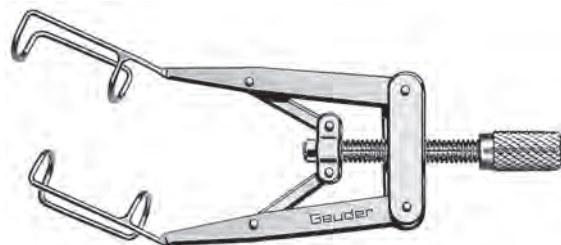
**G-15966***KERSHNER*
EYE SPECULUM

adjustable, reversible
for nasal and temporal placement
15 mm solid blades
overall length 75 mm

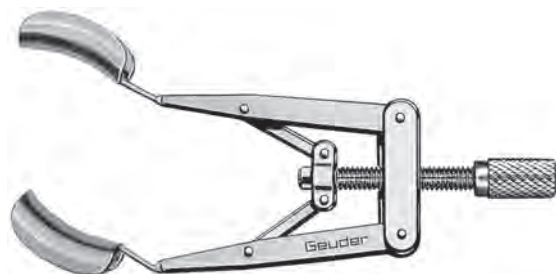

G-33965

DICK
FEMTOCATARACT EYE SPECULUM

adjustable
18 mm flattened fenestrated blades with middle bar to control redundant lid tissue
overall length 80 mm

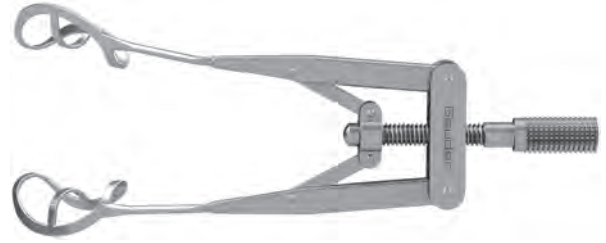

G-33971

SOLOMON
FEMTOCATARACT EYE SPECULUM

14.5 mm flattened fenestrated blades with middle bar to control redundant lid tissue
double knurled screw for fast adjustment and fine tuning
overall length 90 mm



G-33919

SPARE TUBING SET
for eye speculum with aspiration

1/2

G-33920

KNORZ
LASIK EYE SPECULUM
adjustable, with aspiration
16 mm fenestrated blades
to remove excess fluid from the surgical field
supplied with silicone tubing and adaptor

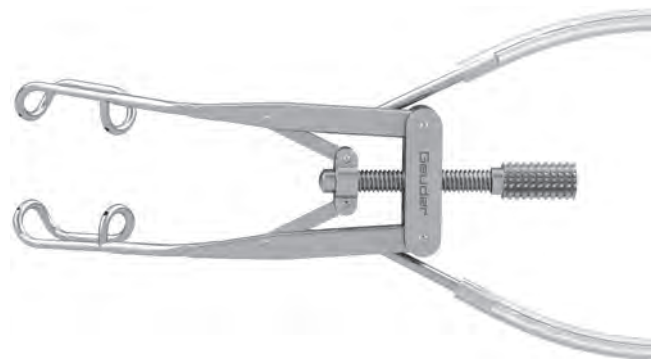

*NODA***EYE SPECULUM**

adjustable, with aspiration
to remove excess fluid from the surgical field
supplied with silicone tubing and adaptor

**G-17019**

15 mm open blades

G-17021

12 mm open blades, for infants

**G-17005***PAULMANN***EYE SPECULUM**

adjustable, with aspiration
for PPV, with extra aspiration bar
16 mm fenestrated blades
to remove excess fluid from the surgical field
supplied with silicone tubing and adaptor

G-17006**CLAMP FOR INFUSION TUBE**for *PAULMANN* eye speculum (G-17005)

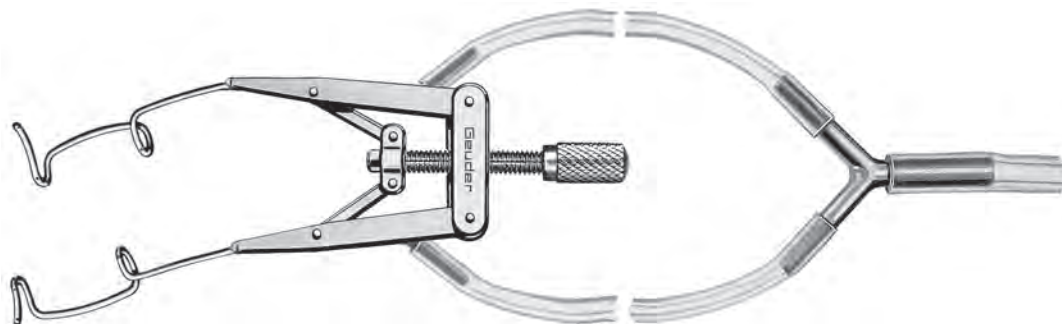

G-15961

LIEBERMANN-TENNANT
EYE SPECULUM

adjustable, with aspiration
for temporal placement
15 mm open blades
overall length 80 mm
to remove excess fluid from the surgical field
supplied with silicone tubing and adaptor



G-17024

KOGA / NODA
EYE SPECULUM

with 5 mm aspiration slits
adjustable
12 mm open blades
to remove excess fluid from the surgical field
supplied with silicone tubing and adaptor



G-17031

NODA

EYE SPECULUM

adjustable, with aspiration
open blades
2 x 10 aspiration ports
supplied with silicone tubing and adaptor



G-15962

KAMMANN

EYE SPECULUM

adjustable, with aspiration
self retaining
11 mm fenestrated blades
to remove excess fluid from the surgical field
supplied with silicone tubing and adaptor

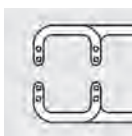



G-33914

*ZIRM***LASIK EYE SPECULUM**

adjustable, with aspiration
 16 mm fenestrated blades
 to remove excess fluid from the surgical field
 supplied with silicone tubing and adaptor

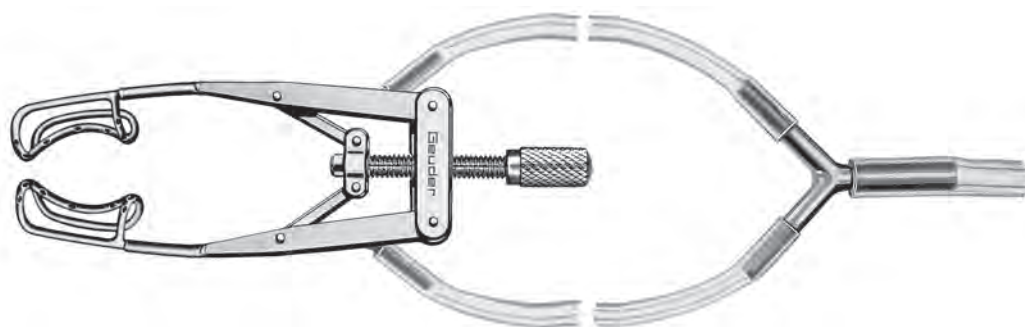

G-33925

*MAUS***LASIK EYE SPECULUM**

adjustable, with middle aspiration bar
 16 mm fenestrated blades
 to remove excess fluid from the surgical field
 supplied with silicone tubing and adaptor

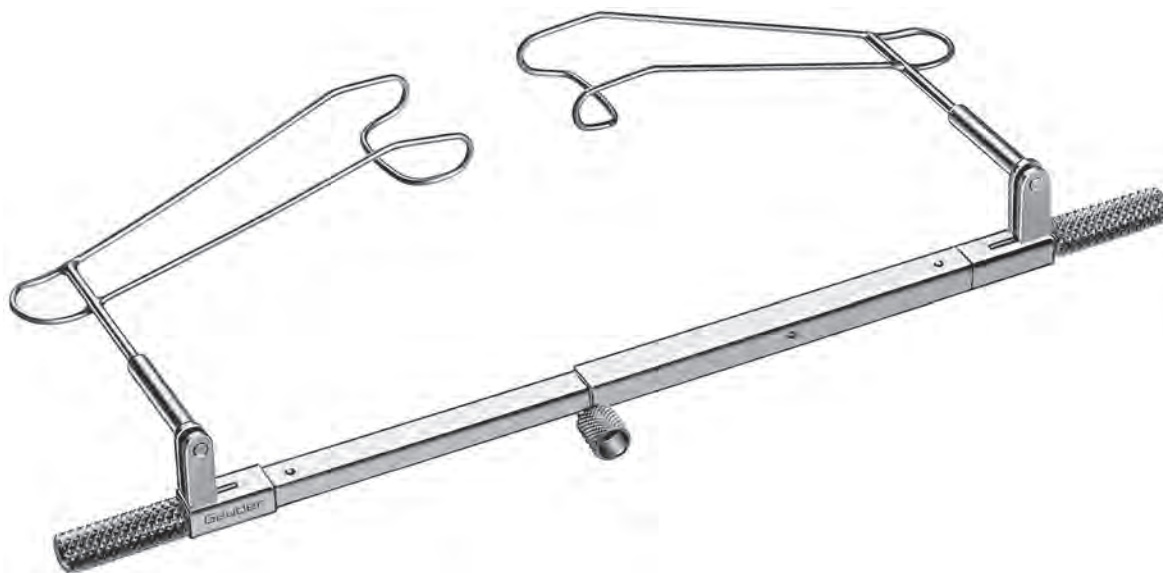
**EYE SPECULUM**

fenestrated blades
adjustable mechanism regulates opening and blade elevation
optimal for glaucoma surgery

G-15920

large, 16 mm blades

G-15925

small, 12 mm blades

*SCHOTT***EYE SPECULUM**

solid blades
adjustable mechanism regulates opening and blade elevation
optimal for glaucoma surgery

G-15921

large, 15 mm blades

G-15926

small, 11 mm blades

01

GLAUCOMA · ADJUSTABLE · ASPIRATION

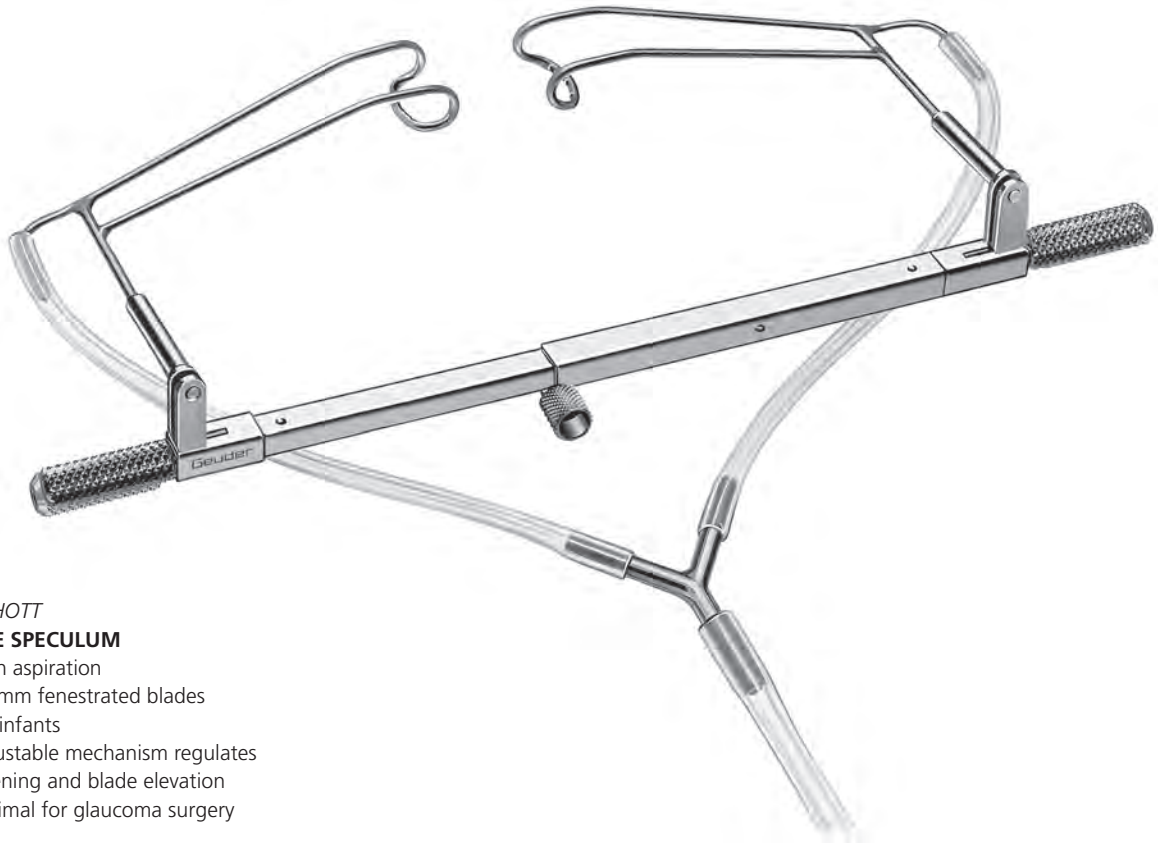

G-15928

SCHOTT
EYE SPECULUM

with aspiration
13 mm fenestrated blades
for infants
adjustable mechanism regulates
opening and blade elevation
optimal for glaucoma surgery

RETRACTORS





G-16080 *DESMARRES*
LID RETRACTOR
for infants
7 mm wide
overall length 133 mm



G-32120 *DESMARRES*
LID RETRACTOR
fig. 0
9 mm wide
overall length 138 mm



G-16060 *DESMARRES*
LID RETRACTOR
fig. 1
12 mm wide
overall length 133 mm



G-16065 *DESMARRES*
LID RETRACTOR
fig. 2
14 mm wide
overall length 135 mm



G-16070 *DESMARRES*
LID RETRACTOR
 fig. 3
 16 mm wide
 overall length 138 mm



G-16075 *DESMARRES*
LID RETRACTOR
 fig. 4
 17 mm wide
 overall length 138 mm



G-32115 *GIESSEN MODEL*
LID RETRACTOR
 14 mm wide, fenestrated
 overall length 133 mm



G-17040 *JAEGER*
LID PLATE
 stainless steel
 20 mm and 23 mm concave ends
 overall length 110 mm



G-15542 *AXENFELD*
LACRIMAL SAC RETRACTOR
4 prongs, blunt
9 mm wide
overall length 140 mm



G-15540 *AXENFELD*
LACRIMAL SAC RETRACTOR
3 prongs, 7 mm wide
overall length 140 mm
blunt
G-15545 sharp



G-15550 *AXENFELD*
LACRIMAL SAC RETRACTOR
2 prongs, 4 mm wide
overall length 140 mm
blunt
G-15555 sharp



G-15560 *ROLLET*
LACRIMAL SAC RETRACTOR
4 prongs, sharp
6 mm wide
overall length 140 mm



GUTHRIE
RETRACTOR
 double skin hook, sharp
 overall length 125 mm
G-15350 small
G-15355 large



G-17085 *AMERICAN MODEL*
LACRIMAL SAC RETRACTOR
 4 x 4 prongs, blunt
 cross-action
 adjustable, self retaining
 overall length 100 mm

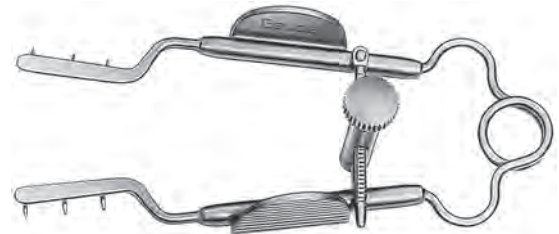

G-17070 *MUELLER*
LACRIMAL SAC RETRACTOR
 3 x 3 prongs
 adjustable
 overall length 70 mm



G-17080 *GOLDSTEIN*
LACRIMAL SAC RETRACTOR
 3 x 3 prongs
 adjustable
 overall length 30 mm

CALIPERS, MARKERS MEASURING INSTRUMENTS TONOMETER, OCULOPRESSOR



CORNEAL MARKERS.....	41
CORNEAL MARKERS · MUSCLE TUCKER.....	42
CALIPERS · RULERS.....	43
RULERS · TRABECULECTOMY MARKER · STRABISMUS MARKER.....	44
LASIK MARKERS · KERATOMETER.....	45
DEGREE GAUGES · AXIS MARKERS.....	46
TORIC MARKERS.....	47
TONOMETER · OCULOPRESSOR.....	48

THOMAS NEUHANN
CORNEAL MARKER
with cross hairs
inside diameter 3.0 mm
outside diameter 12.0 mm
overall length 105 mm

- G-33725** 4 blades
- G-33726** 6 blades
- G-33727** 8 blades

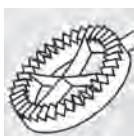

G-32222 *THOMAS NEUHANN*
CORNEAL MARKER
for astigmatic keratotomy
10° scale and cross-hairs
6.0 mm inside diameter
8.0 mm outside diameter
overall length 105 mm



HOFFER
CORNEAL MARKER
for optic zone
with cross hairs
overall length 103 mm
G-33740 inside diameter 7.0 mm
G-33741 inside diameter 7.5 mm
G-33742 inside diameter 8.0 mm



G-38600 *THOMAS NEUHANN*
CORNEAL MARKER
for DSAEK/DSEK/DMEK procedures
combination of 8.0 mm / 9.0 mm diameters
to produce a guide for Descemetorhexis
overall length 123 mm



LINDSTROM

CORNEAL MARKER

to mark arcuate incisions
for surgical correction of astigmatism
overall length 100 mm
optic zone 6.0 mm
G-33780
G-33781



DUNCKER

SUTURE MARKER

8-pointed star and cross hairs
to center the trephine and perform
double running suture
overall length 102 mm
for 7.0 mm transplant
G-32228
G-32229



G-32224

THOMAS NEUHANN

SUTURE MARKER

8 blades
for keratoplasty
fits with KRUMEICH GTS
overall length 102 mm



G-19137

CUEPPERS

STRABISMUS MUSCLE TUCKER

15 mm scale
serrated J-shaped hook to
prevent the muscle from slipping

CASTROVIEJO

CALIPER

scale on both sides
with 1 mm increments

G-19130 15 mm scale, overall length 78 mm

G-19135 20 mm scale, overall length 85 mm



G-19138

OSHER

INCISION MEASURING CALIPER

1 to 10 mm
scale on both sides
for internal measurement of cataract incisions
overall length 75 mm

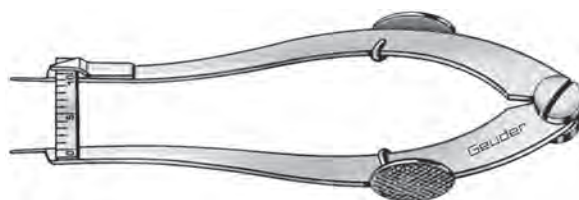

G-37400

BRAUNSTEIN

FIXED CALIPER

for marking of sclerotomy site
at 3.5 mm posterior to the surgical limbus
overall length 45 mm



BRAUNSTEIN

FIXED CALIPER

for marking of sclerotomy site posterior
to the surgical limbus
overall length 80 mm

G-37410 3.0 mm / 3.5 mm

G-37412 3.0 mm / 4.0 mm

G-37414 3.5 mm / 4.0 mm

G-37418 4.0 mm / 5.0 mm



G-18650

RULER

150 mm
0.5 mm and 1.0 mm increments

G-18645 *GIESSEN MODEL*
RULER
vaulted
1 to 30 mm
overall length 60 mm



G-32225 *VOGT*
SCLERAL RULER
vaulted
1 to 20 mm
overall length 126 mm



G-32004 *ENGELS*
MEASURING SPATULA
1 to 15 mm
angled 45°
overall length 88 mm



G-32210 *FRONIMOPOULUS*
TRABECULECTOMY MARKER
5 x 5 mm
U-shaped marking pattern
overall length 70 mm



G-32209 *TOBIAS NEUHANN*
SCLERAL FLAP MARKER
5.0 mm and 4.0 mm
U-shaped marking patterns
swivel handle allows marking from temporal
or superior approach



G-15797 *FINK*
STRABISMUS MARKER
1 mm criss-cross marking tips
for accurate 9 mm recession of the
inferior oblique muscle
overall length 87 mm



G-33785

GRENE
VISUAL AXIS MARKER
0.5 mm diameter
concave tip
overall length 103 mm



G-33745

MENDEZ
LASIK CORNEAL MARKER
for lamellar flap identification
and realignment
overall length 105 mm

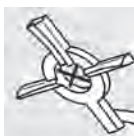

G-33746

CHAYET
LASIK CORNEAL MARKER
for lamellar flap identification
and realignment
overall length 105 mm



G-33747

LU
LASIK CORNEAL MARKER
for lamellar flap identification
and realignment
overall length 105 mm



G-32318

MALONEY
KERATOMETER
for qualitative measurement of astigmatism
overall length 20 mm



G-33760

MENDEZ

DEGREE GAUGE

measures from 0° to 180°
5° increments
12 mm inside diameter
overall length 110 mm



G-33762

DEGREE GAUGE

for toric IOLs
with 5° increments and
rotating alignment rings
12 mm inside diameter
overall length 110 mm



G-33763

GERTEN

HORIZONTAL AXIS MARKER

for precise marking of the 0° axis
during toric IOL implantation
or refractive laser surgery
overall length 105 mm



G-33774

SCOTT

CORNEAL PENDULUM MARKER

for temporary placement of
0°, 90°, and 180° pre-op toric marks
self-leveling pendulum assures precise
horizontal axis
overall length 110 mm



G-33777

**TOMARK
ADJUSTABLE CORNEAL MARKER**

to mark the axis of astigmatism during toric IOL placement
0° to 180° degree gauge
5° increments
overall length 32 mm



for use in combination with slit lamp or G-33776

03

TORIC MARKERS



G-33776

TOMARK PENDULUM INSTRUMENT

self-leveling handheld pendulum assures precise
horizontal axis
overall length 140 mm

to retain TOMARK corneal marker G-33777

G-33778

RETAINER FOR PENDULUM INSTRUMENT

for G-33776 TOMARK
overall length 180 mm

1/2



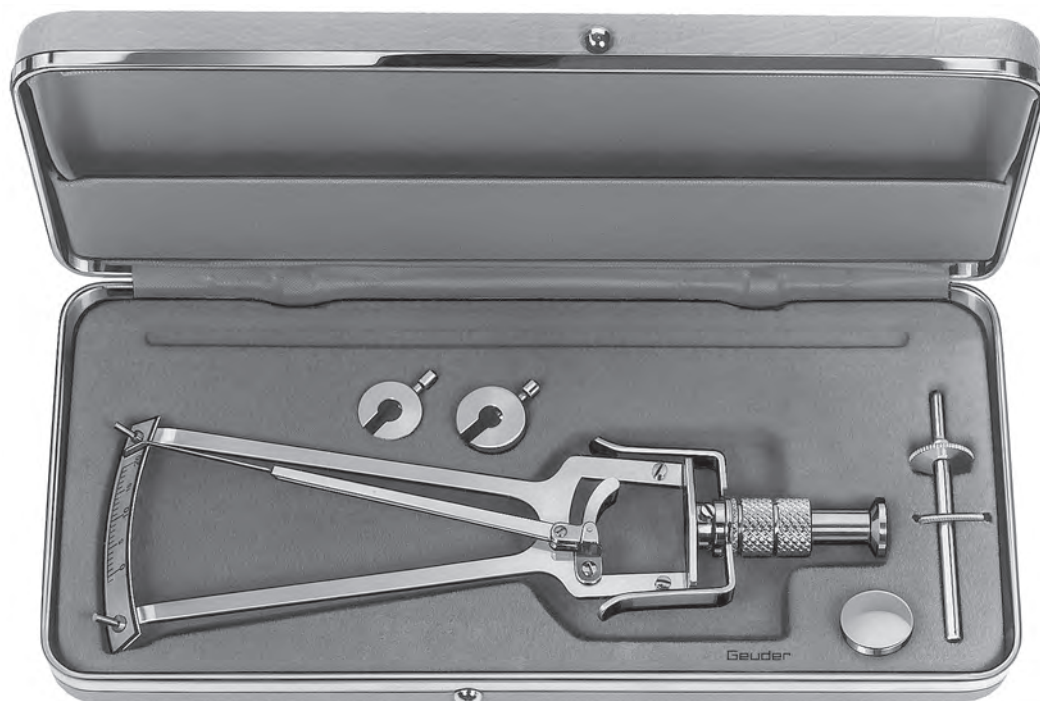

G-19230 *SCHIOETZ*
TONOMETER
with two weights of 7.5 g and 10 g

G-15392 *HOMBURG MODEL*
OCULOPRESSOR

G-15393 **SILICONE BALL**
with band, for Oculopressor
HOMBURG MODEL G-15392



CURETTES SPOONS





G-15900 *MEYHOEFER*
CHALAZION CURETTE
1.0 mm diameter cup
overall length 129 mm



G-15870 *MEYHOEFER*
CHALAZION CURETTE
2.0 mm diameter cup
overall length 129 mm



G-15875 *MEYHOEFER*
CHALAZION CURETTE
2.5 mm diameter cup
overall length 129 mm



G-15880 *MEYHOEFER*
CHALAZION CURETTE
3.0 mm diameter cup
overall length 129 mm



G-15885 *MEYHOEFER*
CHALAZION CURETTE
4.0 mm diameter cup
overall length 129 mm



G-15840 *HEBRA*
CHALAZION CURETTE
 small
 2.5 mm x 4.0 mm oval scoop
 overall length 133 mm



G-15845 *HEBRA*
CHALAZION CURETTE
 medium
 3 mm x 5 mm oval scoop
 overall length 133 mm



G-15910 *AXENFELD*
CHALAZION CURETTE
 double ended
 4.5 x 2.5 mm and 6.5 x 3.0 mm oval currettes
 overall length 144 mm



G-31545 *BUNGE*
EXENTERATION CURETTE
 medium
 10 mm spoon
 overall length 142 mm



G-31555 *BUNGE*
EXENTERATION CURETTE
 large
 12 mm spoon
 overall length 144 mm

04

CHALAZION · ENUCLEATION

FOREIGN BODY INSTRUMENTS





G-14550 **FOREIGN BODY INSTRUMENT**
double-ended with sliding handle
2.2 mm wide curved needle
1 mm wide *PLANGE* spud
overall length 95 mm



G-14540 **FOREIGN BODY INSTRUMENT**
double ended with sliding handle
2.2 mm wide curved needle
1.4 mm wide gouge
overall length 95 mm



G-14530 **FOREIGN BODY INSTRUMENT**
double ended with sliding handle
2.2 mm wide curved needle
1.4 mm wide spud
overall length 95 mm

G-14490

FOREIGN BODY NEEDLE

straight
4.5 mm long triangular tip
2.4 mm wide
overall length 120 mm



G-14500

FOREIGN BODY NEEDLE

curved
4.5 mm long triangular tip
2.4 mm wide
overall length 120 mm



G-14570

PLANGE
FOREIGN BODY SPUD

curved and rounded
1 mm wide spud
overall length 125 mm



G-14480

FOREIGN BODY GOUGE

straight
1.4 mm wide gouge
overall length 116 mm



05

FOREIGN BODY SPUDS · NEEDLES · GOUGES

KNIVES DIAMOND KNIVES



PARACENTESIS · SIDEPORT · UNIVERSAL	59
TRIFACET · CLEAR CORNEA	60
CRESCENT · STEP TRIFACET · LRI	61
MICROMETER · VISCOCANALOSTOMY · RETINAL SURGERY	62
KERATOME · CHALAZION · SCLERAL	63
CORNEAL SCARIFIER · DMEK SCRAPER	64
SATO	65
CRVO	66



G-38475 **DIACLEAN DIAMOND KNIFE**
for paracentesis
1 mm wide spear
titanium handle
width 1.0 mm
length 4.0 mm
thickness 0.2 mm

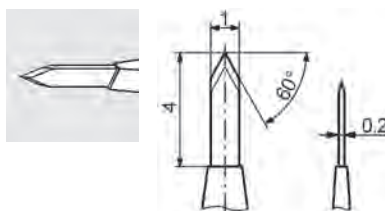

G-38344 **DIACLEAN DIAMOND KNIFE**
1 mm wide, 45° diamond blade
titanium handle
width 1.0 mm
length 3.0 mm
thickness 0.2 mm

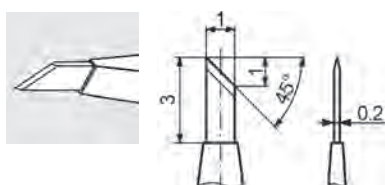

G-38341 **DIACLEAN DIAMOND KNIFE**
60° spear diamond blade
titanium handle
width 1.4 mm
length 3.0 mm
thickness 0.2 mm

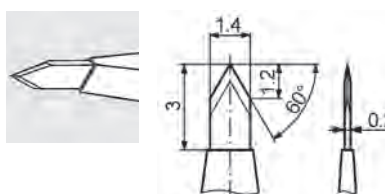

G-38343 **DIACLEAN DIAMOND KNIFE**
45° spear diamond blade
titanium handle
width 1.4 mm
length 3.0 mm
thickness 0.2 mm

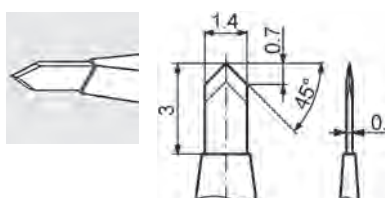



G-38342 DIACLEAN TRI-FACET DIAMOND KNIFE

1 mm wide tri-facet diamond blade
titanium handle
width 1.0 mm
length 3.0 mm
thickness 0.2 mm

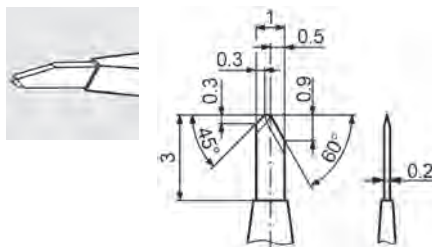

06



G-38473 PHAM DIACLEAN TRI-FACET DIAMOND KNIFE

titanium handle
width 1.5 mm
length 3.0 mm
thickness 0.2 mm

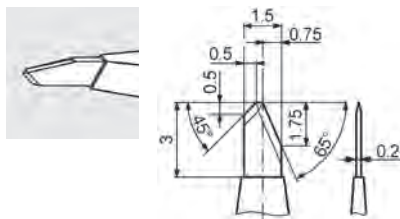

DIAMOND KNIVES: TRI-FACET · CLEAR CORNEA · TRAPEZOID · PHACO



G-38448 DIACLEAN CLEAR-CORNEA-INCISION DIAMOND KNIFE, 1.5/2.0 mm

MICS trapezoid blade, 35° angled
4 cutting edges
titanium handle
width 1.5 / 2.0 mm
length 5.0 mm
thickness 0.2 mm

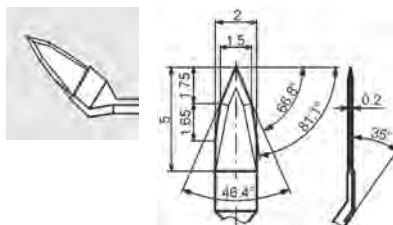

G-38444 DIACLEAN CLEAR-CORNEA-INCISION DIAMOND KNIFE, 2.2 MM

4 cutting edges, 35° angled
titanium handle
width 2.2 mm
length 5.0 mm
thickness 0.2 mm

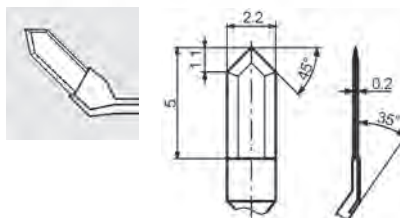



G-38453 **DIACLEAN CLEAR-CORNEA-INCISION
DIAMOND KNIFE, 2.85 MM**
4 cutting edges, 35° angled
titanium handle
width 2.85 mm
length 5.0 mm
thickness 0.2 mm

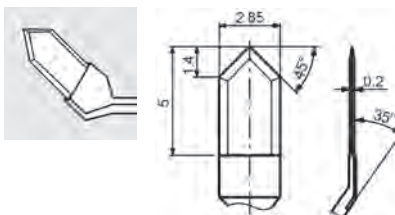

G-38466 **DIACLEAN DIAMOND
CRESCENT KNIFE, 2.0 MM**
round spatula shape, 40° angled
titanium handle
width 2.0 mm
length 4.0 mm
thickness 0.2 mm

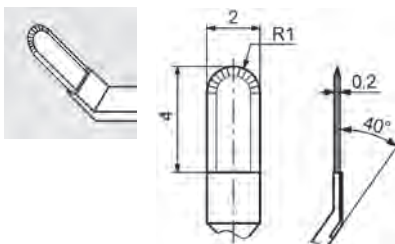

G-31470 **TRI-FACET DIAMOND STEP KNIFE**
single footplate, titanium handle
stepwise adjustable
in sterilizing case
width 1.0 mm
length 3.0 mm
thickness 0.2 mm

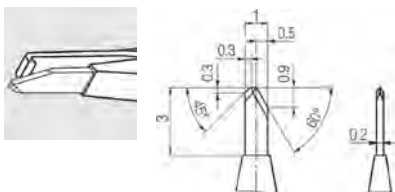

G-31468 **LIMBAL RELAXING INCISION
DIAMOND KNIFE**
LRI knife with 0.6 mm precalibrated depth
single footplate, titanium handle
width 1.0 mm
length 3.0 mm
thickness 0.2 mm

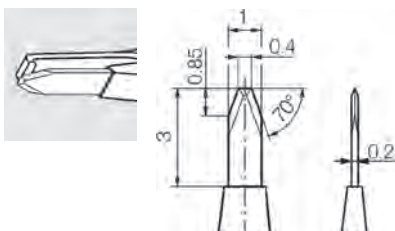

G-31480

DIAMOND MICROMETER KNIFE

tri-facet for keratotomy
vertical and 15° cutting edges with
0.2 mm flat base cutting edge
double footplate, titanium handle
width 0.6 mm
length 3.0 mm
thickness 0.1 mm

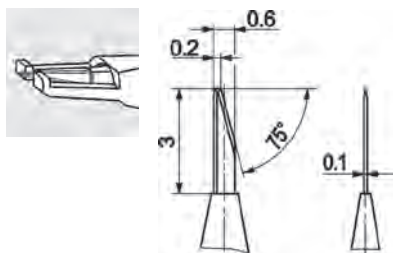

G-19345

DIAMOND MICROMETER KNIFE

for keratotomy
single 45° cutting edge
double footplate, titanium handle
width 1.0 mm
length 3.0 mm
thickness 0.2 mm

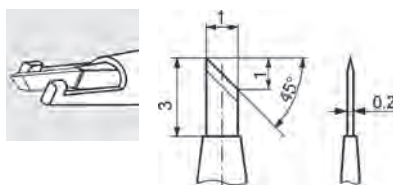

G-31487

DIAMOND KNIFE

for viscocanalostomy
0.5 mm wide, 70° diamond blade
width 0.5 mm
length 4.0 mm
thickness 0.2 mm

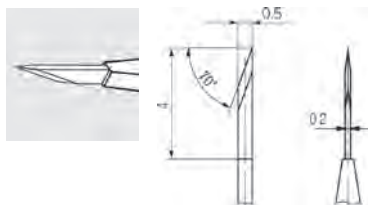

G-31477

RETINA DIAMOND KNIFE

45° cutting edge
20 gauge / 0.9 mm
titanium handle
width 0.9 mm
length 3.0 mm
thickness 0.2 mm

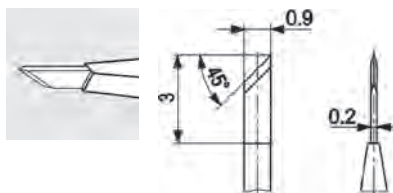



G-14420 *HAMBURG MODEL*
KERATOME
angled at 14 mm from tip
10 mm cutting surface
1.1 mm wide
overall length 120 mm



G-14000 **CHALAZION KNIFE**
straight, delicate
10 mm cutting surface
1.8 mm wide
overall length 120 mm



G-14105 **MICRO ROUND KNIFE**
for viscocanalostomy
0.8 mm diameter disc-shaped blade
overall length 112 mm



G-14180 *BONN MODEL*
SCLERAL KNIFE
7 mm blade, rounded tip
overall length 126 mm



G-14185 *BONN MODEL*
SCLERAL KNIFE
4 mm blade, rounded tip
overall length 126 mm



KUHNT
CORNEAL SCARIFIER

rounded tip
overall length 123 mm
fig. 1, 5.5 mm x 2.5 mm blade
fig. 2, 4.5 mm x 2.0 mm blade

G-14010
G-14020



G-38621 *SZURMAN*
DMEK PREPARATION SCRAPER

4.0 mm lower blade, blunt
1.5 mm rounded tip, sharp
for removal of Descemet's membrane from graft
overall length 117 mm



G-14200 *PAUFIQUE*
KERATOPLASTY KNIFE
2 mm long cutting edge
1.7 mm wide semi-circular tip
overall length 105 mm



G-33670 *LOHMANN*
LASEK EPI PEELER
"Hockey" knife with
5 mm bottom blade and 2 mm front blade
overall length 123 mm



STILETTO
45° lancet
overall length 53 mm
for instruments with

G-33022
G-33025
G-33026

23 gauge / 0.6 mm
20 gauge / 0.9 mm
19 gauge / 1.1 mm



G-14165

SATO KNIFE

1.5 mm cutting edge
pointed tip
overall length 123 mm



G-16200

DARDENNE
SATO KNIFE

1.2 mm cutting edge
pointed tip
overall length 123 mm



G-37555

FOERSTER
SATO KNIFE

conical shaft
front: 30 gauge / 0.3 mm
rear: 20 gauge / 0.9 mm
overall length 125 mm



G-14162

HANSEN
SATO KNIFE

double edge,
for arteriovenous dissection
20 gauge / 0.9 mm
overall length 130 mm



06

SATO



G-12200

CRVO KNIFE

for Radial Opticus Neurotomy (RON)
with Central Retinal Vein Occlusion (CRVO),
20 gauge / 0.9 mm
overall length 120 mm



G-12220

DITHMAR

CRVO KNIFE

with preset incision depths at 1.5 mm,
for radial opticus neurotomy (RON)
with Central Retinal Vein Occlusion (CRVO),
20 gauge / 0.9 mm
overall length 129 mm



06

CRVO

TREPHINES



BEST
TREPHINE
overall length 58 mm



G-31815	1.0 mm
G-31820	1.2 mm
G-31825	1.3 mm
G-31830	1.4 mm

G-31835	1.5 mm
G-31840	1.6 mm
G-31845	1.7 mm
G-31850	1.8 mm

G-31855	1.9 mm
G-31860	2.0 mm
G-31865	2.5 mm

SCHMIDT-MUMM
DUCT TREPHINE
overall length 38 mm



G-20610	1.0 mm
G-20611	1.1 mm
G-20612	1.2 mm

G-20613	1.3 mm
G-20614	1.4 mm
G-20615	1.5 mm

G-20616	1.6 mm
G-20617	1.7 mm
G-20618	1.8 mm

HAMBURG MODEL
KERATOPLASTY TREPHINE
overall length 40 mm



G-20050	5.0 mm
G-20054	5.4 mm
G-20055	5.5 mm

G-20060	6.0 mm
G-20065	6.5 mm
G-20070	7.0 mm

G-20080	8.0 mm
G-20090	9.0 mm
G-20100	10.0 mm

BEST
KERATOPLASTY TREPHINE
overall length 75 mm



G-20450	5.0 mm
G-20455	5.5 mm
G-20460	6.0 mm
G-20465	6.5 mm

G-20470	7.0 mm
G-20480	8.0 mm
G-20490	9.0 mm
G-20500	10.0 mm

FRANCESCHETTI
KERATOPLASTY TREPHINE
overall length 75 mm



G-17250	5.0 mm
G-17251	5.1 mm
G-17260	6.0 mm
G-17261	6.1 mm

G-17270	7.0 mm
G-17271	7.1 mm
G-17280	8.0 mm
G-17281	8.1 mm

G-17290	9.0 mm
G-17291	9.1 mm
G-17300	10.0 mm

MANY TREPHINES ALSO AVAILABLE IN MINUS, INTERMEDIATE AND PLUS SIZES

G-31870

THOMAS NEUHANN

CORNEAL PUNCH

for keratoplasty trephines with thread from G-33870 to G-33899, with silicone block for donor cornea

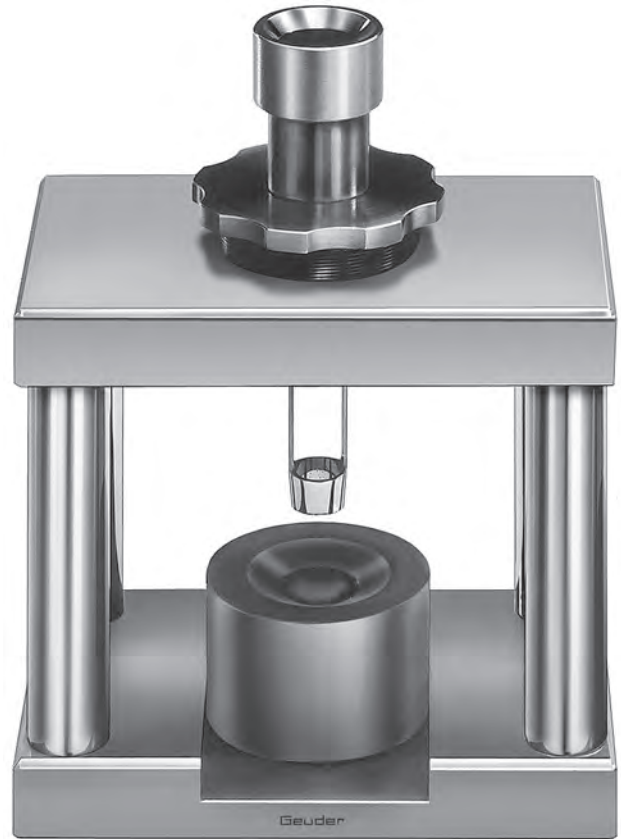

07

TREPHINES · PUNCH

KERATOPLASTY TREPHINE

with thread, for NEUHANN corneal punch G-31870 overall length 40 mm



G-33870	7.0 mm	G-33880	8.0 mm	G-33890	9.0 mm
G-33871	7.1 mm	G-33881	8.1 mm	G-33891	9.1 mm
G-33872	7.2 mm	G-33882	8.2 mm	G-33892	9.2 mm
G-33873	7.3 mm	G-33883	8.3 mm	G-33893	9.3 mm
G-33874	7.4 mm	G-33884	8.4 mm	G-33894	9.4 mm
G-33875	7.5 mm	G-33885	8.5 mm	G-33895	9.5 mm
G-33876	7.6 mm	G-33886	8.6 mm	G-33896	9.6 mm
G-33877	7.7 mm	G-33887	8.7 mm	G-33897	9.7 mm
G-33878	7.8 mm	G-33888	8.8 mm	G-33898	9.8 mm
G-33879	7.9 mm	G-33889	8.9 mm	G-33899	9.9 mm

G-32671 *ÖRK LINZ MODEL*
SILICONE BLOCK FOR DMEK
for donor cornea
white-colored



G-32672 **SILICONE BLOCK**
for donor cornea
blue-colored



G-32674 **SILICONE BLOCK WITH CENTER POINT**
for donor cornea



G-38620 *SZURMAN*
DMEK GRAFT RETAINER
for preparation of DMEK graft



07

SILICONE BLOCKS

G-21175 **METAL STAND**
with removable silicone insert G-21176
for aspiration of donor cornea



G-21176 **SILICONE INSERT**
for metal stand G-21175



07

SILICONE BLOCKS

GLAUCOMA PUNCHES RONGEURS

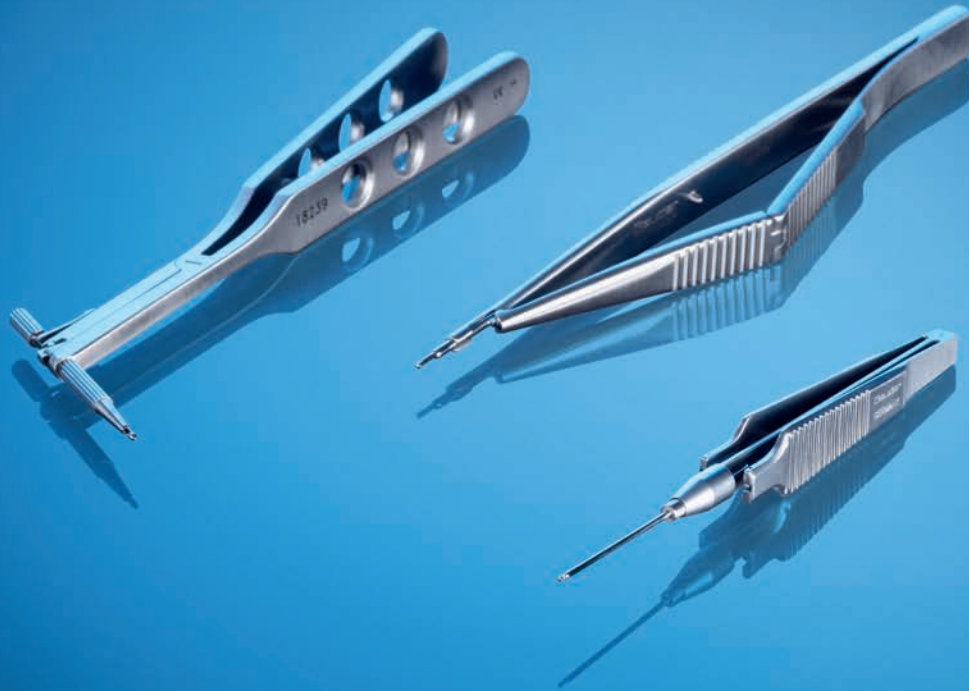

G-18210

CITELLI

BONE NIBBLING RONGEUR

3 mm x 4.5 mm bite
overall length 150 mm

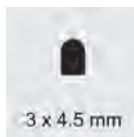

2/5



G-18220

BEYER

BONE NIBBLING RONGEUR

2 mm x 3 mm bite
overall length 140 mm

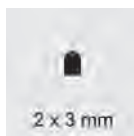

2/5

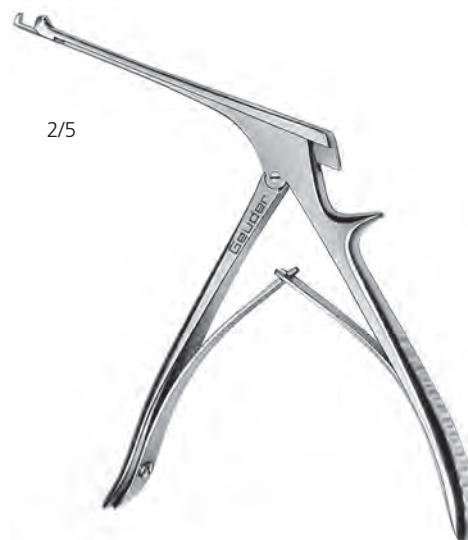

G-18225

KERRISON

BONE NIBBLING RONGEUR

5 mm x 3.5 mm bite
overall length 160 mm

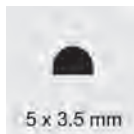

2/5



08

RONGEURS

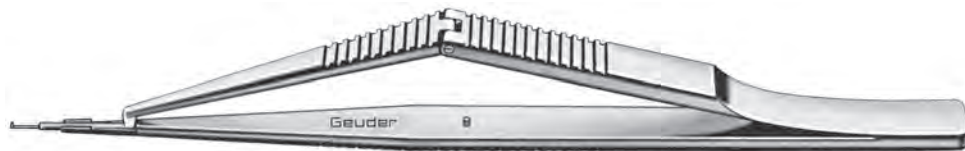

G-18238

KELLY
DESCEMET'S MEMBRANE PUNCH
 for Glaucoma
 19 gauge / 1.0 mm
 0.9 mm x 0.45 mm bite
 overall length 122 mm

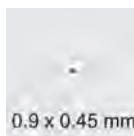

G-18239

LUNTZ-DODICK
TRABECULECTOMY PUNCH
 for Glaucoma
 with 360° rotatable cutting head
 1 mm x 0.5 mm bite
 overall length 115 mm

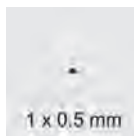

G-18235

GREHN
MICRO TRABECULECTOMY PUNCH
 for Glaucoma
 20 gauge / 0.9 mm
 0.7 mm x 0.3 mm bite
 overall length 90 mm

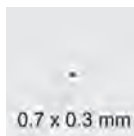

08

GLAUCOMA PUNCHES



G-18237 *GASS*
CORNEOSCLERAL PUNCH
for Glaucoma
with 360° rotatable cutting head
1.5 mm x 0.6 mm bite
overall length 85 mm

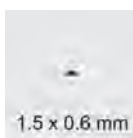

G-18232 *MOHR*
GLAUCOMA PUNCH
1 mm circular bite
overall length 78 mm

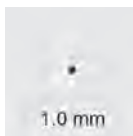



CORNEAL	81
STITCH	82
CAPSULE	84
IRIS	86
IOL	87
TENOTOMY	89
STRABISMUS	90
MISCELLANEOUS · RING HANDLE	91
ENUCLEATION	94
VITREORETINAL	95

TROUTMAN

CORNEAL SCISSORS

7 mm blades
9.5 mm from tip to pivot
overall length 100 mm
right, curved blades, blunt tips
left, curved blades, blunt tips

G-19710
G-19715



CASTROVIEJO

CORNEAL SCISSORS

lower blade 9.5 mm
upper blade 9.0 mm
overall length 105 mm
right, curved blades, blunt tips
left, curved blades, blunt tips

G-19690
G-19695



KATZIN

KERATOPLASTY SCISSORS

6 mm blades
8 mm from tip to pivot
overall length 100 mm
right, curved blades, blunt tips
left, curved blades, blunt tips

G-19720
G-19725



G-19718

SAUTTER

CORNEAL SCISSORS

light curve, fine blunt tips
10 mm blades
14 mm from tip to pivot
overall length 100 mm



G-19780

CASTROVIEJO

CORNEAL SCISSORS

strong curve, blunt tips
12 mm blades
15 mm from tip to pivot
overall length 103 mm



G-19790

CASTROVIEJO

CORNEAL SCISSORS

angled to side, blunt tips
12 mm blades
overall length 110 mm



CORNEAL SCISSORS

light curve
8 mm blades
overall length 105 mm
sharp tips
blunt tips

G-19600
G-19605



CORNEAL SCISSORS

strong curve, blunt tips
6 mm blades, overall length 105 mm
11 mm blades, overall length 110 mm

G-19607
G-19615



G-19727

MACKENSEN
KERATOPLASTY SCISSORS
strong curve, blunt tips
overall length 85 mm



G-19585

CORNEAL SECTION SCISSORS
angled up, 8 mm blades
blunt tips
overall length 100 mm



G-19570

MICRO STITCH SCISSORS
straight, 8 mm blades
sharp tips
overall length 105 mm



G-19580

FINE
STITCH SCISSORS
straight, 14 mm blades
sharp tips
overall length 110 mm



09

CORNEAL · CORNEAL SECTION · STITCH

G-19590 *CASTROVIEJO*
ANTERIOR SYNECHIA SCISSORS
angled up
9 mm vaulted blades, blunt tips
overall length 105 mm



G-19740 *CASTROVIEJO*
ANTERIOR SYNECHIA SCISSORS
angled up
15 mm vaulted blades, blunt tips
overall length 115 mm



TRABECULUM SCISSORS

sharp tips
8.5 mm blades
1.5 mm pivot width
overall length 80 mm



G-19745 straight
G-19747 curved

CAPSULOTOMY SCISSORS

angled up, sharp tips
2 mm pivot width
overall length 80 mm



G-19776 9 mm blades
G-19777 11 mm blades

G-32100 **CAPSULOTOMY SCISSORS**

angled, lightly curved tips
13 mm blades
2 mm pivot width
overall length 80 mm



G-32101 **CAPSULOTOMY SCISSORS**

angled, strongly curved tips
13 mm blades
2 mm pivot width
overall length 80 mm



G-32105 **CAPSULOTOMY SCISSORS**

lightly curved, sharp tips
11 mm blades
1.8 mm pivot width
overall length 88 mm



G-32023 **CAPSULOTOMY SCISSORS**
 curved, sharp tips
 7 mm blades
 1.8 mm pivot width
 overall length 80 mm



G-19620 *TUEBINGEN MODEL*
CAPSULOTOMY SCISSORS
 straight, sharp tips
 9 mm blades
 1.8 mm pivot width
 overall length 88 mm



G-19630 *TUEBINGEN MODEL*
CAPSULOTOMY SCISSORS
 curved, sharp tips
 9 mm blades
 1.8 mm pivot width
 overall length 88 mm



G-19760 *VANNAS*
CAPSULOTOMY SCISSORS
 extra delicate, straight
 6 mm blades, sharp tips
 1.7 mm pivot width
 overall length 80 mm



G-19765 *VANNAS*
CAPSULOTOMY SCISSORS
 extra delicate, curved
 6 mm blades, sharp tips
 1.7 mm pivot width
 overall length 80 mm



G-19770 *VANNAS*
CAPSULOTOMY SCISSORS
 extra delicate, angled to side
 7 mm blades, sharp tips
 overall length 80 mm



09

CAPSULOTOMY · CAPSULE

G-19775 *VANNAS*
CAPSULOTOMY SCISSORS
extra delicate, angled up
7 mm blades, sharp tips
overall length 80 mm



G-32940 *H.-R. KOCH*
CAPSULE SCISSORS
horizontal, 45° angled
2.5 mm blades, 360° rotatable head
22 gauge / 0.7 mm straight shaft
overall length 107 mm



G-32942 *BRAUWEILER*
CAPSULE SCISSORS
vertical, 1.25 mm blades
22 gauge / 0.7 mm curved shaft
overall length 100 mm



G-38246 *YAE*
CAPSULE SCISSORS
interchangeable, titanium, gold-colored
3 mm straight micro blades
23 gauge / 0.6 mm curved shaft
for cutting synechia, iridotomies,
and to rescue the rhexis during MICS
overall length 42 mm
for use with handle G-38240



G-38240 *JAPAN MODEL*
HANDLE
for capsule scissors and forceps
6 mm, titanium
overall length 90 mm



09

CAPSULOTOMY · ROTATABLE · INTERCHANGEABLE



OSHER
CAPSULE SCISSORS
 360° rotatable and interchangeable tips
 22 gauge / 0.7 mm
 overall length 45 mm
 to use with handpiece
 G-38215



OSHER
CAPSULE SCISSORS
 45° angled
 G-38232



OSHER
CAPSULE SCISSORS
 horizontal, 45° angled
 G-38236



OSHER
CAPSULE SCISSORS
 horizontal, 90° angled
 G-38238

OSHER
HANDPIECE FOR CAPSULE SCISSORS
 8 mm titanium handpiece, gold-colored
 G-38215



09

CAPSULE (INTERCHANGEABLE AND ROTATABLE) · IRIS

G-32948

HATTENBACH
HYBRID SCISSORS
 to cut sutures during iris and dislocated IOL fixation
 1.25 mm blades
 25 gauge / 0.5 mm angled shaft



G-19540
 G-19545
 G-19550

NOYES
IRIS SCISSORS
 straight
 18 mm blades
 overall length 120 mm
 sharp tips
 sharp-blunt
 blunt tips



G-19640
 G-19655

WECKER
IRIS SCISSORS
 11 mm blades
 overall length 110 mm
 sharp tips
 blunt tips



WECKER
IRIS SCISSORS
7 mm blades
overall length 110 mm
sharp tips
blunt tips

G-19660
G-19675



G-19680 *BARRAQUER*
IRIS SCISSORS
7 mm blades
blunt tips
overall length 56 mm



G-32945 *STEINMETZ*
IOL SCISSORS
6.5 mm upper blade
serrated lower tip with groove
overall length 92 mm
For cutting acrylic and silicone foldable IOLs



G-32946 *STEINMETZ*
IOL SCISSORS
for small incision technique
6.5 mm upper blade
serrated lower tip with groove
overall length 92 mm
For cutting acrylic and silicone foldable IOLs



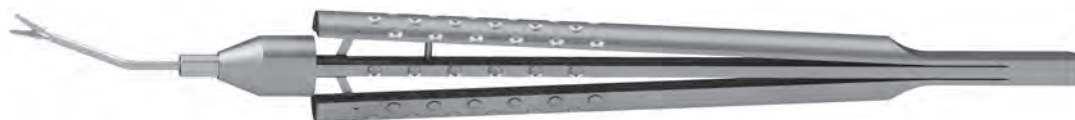

SNYDER-OSHER

IOL SCISSORS

For cutting acrylic and silicone foldable IOLs
 lower notched blade to create IOL traction
 18 gauge / 1.2 mm shaft
 overall length 150 mm
 short model, 3.5 mm blades
 long model, 4.5 mm blades



G-32998
G-32996



G-32800

H.-R. KOCH

SILICONE LENS BI-SECTOR

for dividing implanted silicone lenses
 overall length without wire loop 130 mm
 5 wire loops included (G-32811)

WIRE LOOP

for *H.-R. KOCH* silicone lens bi-sector
 (G-32800)
 overall length 65 mm (loop 12 mm)

G-32810
G-32811

1 piece
 5 pieces



**COMBINED
 NEEDLE HOLDER / SCISSORS**

curved 12 mm blades with
 3 mm needle holder and tying platform
 used to hold, place, and cut fine suture material
 overall length 125 mm
 without lock
 with lock



G-17440
G-17441

G-19750 *WESTCOTT*
SCISSORS
blunt tips
curved, standard blades
overall length 120 mm



G-19751 *WESTCOTT*
SCISSORS
pointed tips
curved, standard blades
overall length 120 mm



G-32250 *WESTCOTT*
SCISSORS
blunt tips
curved, delicate blades
overall length 100 mm



STEVENS
TENOTOMY SCISSORS
short blades, blunt tips
22 mm from tip to pivot
overall length 105 mm
G-19470 straight
G-19475 curved



STEVENS
TENOTOMY SCISSORS
long blades, blunt tips
28 mm from tip to pivot
overall length 110 mm
G-19480 straight
G-19485 curved



G-32614

BONN MODEL

TENOTOMY SCISSORS

curved blades, blunt tips
24 mm from tip to pivot
overall length 90 mm



G-19430

BONN MODEL

STRABISMUS SCISSORS

blunt tips
24 mm from tip to pivot
overall length 90 mm

G-19435

straight

curved



G-19420

STRABISMUS SCISSORS

long blade
28 mm from tip to pivot
overall length 105 mm

G-19425

straight

curved



09

TENOTOMY · STRABISMUS · RING HANDLE

STRABISMUS SCISSORS

short blade
28 mm from tip to pivot
overall length 110 mm
straight
curved

G-19460
G-19465



EYE SCISSORS

straight, sharp tips
overall length: tip to pivot:

G-19350
G-19355
G-19360
G-19365

90 mm	27 mm
100 mm	29 mm
110 mm	30 mm
120 mm	36 mm



EYE SCISSORS

curved, sharp tips
overall length: tip to pivot:

G-19370
G-19375
G-19380
G-19385

90 mm	25 mm
100 mm	28 mm
110 mm	29 mm
120 mm	34 mm



EYE SCISSORS

delicate, sharp tips
31 mm from tip to pivot
overall length 105 mm

G-19390

straight

G-19395

curved



BONN MODEL
EYE SCISSORS

extra delicate
sharp tips
19 mm from tip to pivot
overall length 90 mm

G-19400

curved

G-19405

straight



G-19410

SPENCER
STITCH SCISSORS

20 mm straight blades
with hook to lift and
secure sutures before cutting
overall length 90 mm



09

UTILITY · STITCH · RING HANDLE

G-19450 *GRAEFE*
EYE SCISSORS
angled up
blunt tips
overall length 90 mm



G-19505 **EYE SCISSORS**
angled to side, probe tip
sharp-blunt
overall length 115 mm



G-19510 **EYE SCISSORS**
angled to side, probe tips
blunt tips
overall length 115 mm



G-31315

OPERATING SCISSORS

straight blades
sharp-blunt
overall length 145 mm



ENUCLEATION SCISSORS

curved blades, blunt
40 mm from tip to pivot
overall length 135 mm

G-19520

G-19525

G-19530

strong curve
medium curve
light curve



09

UTILITY · ENUCLEATION · RING HANDLE

20 GAUGE

VITREORETINAL SCISSORS

20 gauge / 0.9 mm
titanium handle
gold-colored
overall length 155 mm



45° angle
horizontal
G-36502 6 mm handle
G-36504 8 mm handle



curved
with membrane peeler
G-36506 6 mm handle
G-36508 8 mm handle



curved
G-36512 6 mm handle
G-36514 8 mm handle



KROLL
angled, with membrane peeler
G-36516 6 mm handle
G-36518 8 mm handle



angled, blunt tips
for MIS
G-36522 6 mm handle
G-36524 8 mm handle



HEIMANN
angled
G-36526 6 mm handle
G-36528 8 mm handle

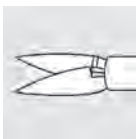

HEIMANN
straight
G-36532 6 mm handle
G-36534 8 mm handle

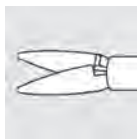

HEIMANN
straight, blunt tips
G-36536 6 mm handle
G-36538 8 mm handle



60° angled
G-36546 6 mm handle
G-36548 8 mm handle



curved
horizontal
G-36552 6 mm handle
G-36554 8 mm handle



NAITO
long blade 3.5 mm
curved, tapered tip
G-36556 6 mm handle
G-36558 8 mm handle



ROIDER
for RPE transplantation, vitrectomies
and retinectomies
G-36572 6 mm handle
G-36574 8 mm handle

23 GAUGE

VITREORETINAL SCISSORS

23 gauge / 0.6 mm
titanium handle
gold-colored
overall length 155 mm



curved

G-36566 6 mm handle
G-36568 8 mm handle

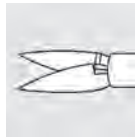

HEIMANN
straight

G-36576 6 mm handle
G-36578 8 mm handle



HEIMANN
for use with 23 gauge trocar system
angled, sharp tips

G-36540 6 mm handle
G-36541 8 mm handle

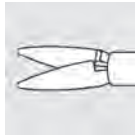

HEIMANN
straight, blunt tips

G-36582 6 mm handle
G-36584 8 mm handle

25 GAUGE

VITREORETINAL SCISSORS

25 gauge / 0.5 mm
titanium handle
gold-colored



curved

G-36562 6 mm handle
G-36564 8 mm handle

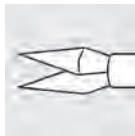

HEIMANN
straight

G-36586 6 mm handle
G-36588 8 mm handle

ERGOLINE

ERGOLINE SCISSORS

360° rotatable and interchangeable tips
for Ergoline handles 6 and 8 mm diameter
overall length 55 mm

ERGOLINE HANDPIECE

for Ergoline scissors
gold-colored
overall length 105 mm

G-36900 6 mm titanium handpiece

G-36901 8 mm titanium handpiece

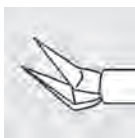

ERGOLINE SCISSORS

45° angled
horizontal
20 gauge / 0.9 mm
G-36902



KROLL

ERGOLINE SCISSORS

angled, with membrane peeler
20 gauge / 0.9 mm
G-36915



HEIMANN

ERGOLINE SCISSORS

angled
20 gauge / 0.9 mm
G-36925

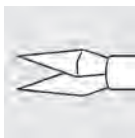

HEIMANN

ERGOLINE SCISSORS

straight
G-36930 20 gauge / 0.9 mm
G-36975 23 gauge / 0.6 mm
G-36985 25 gauge / 0.5 mm



NAITO

ERGOLINE SCISSORS

long blade 3.5 mm, curved
tip tapered to 0.75 mm
20 gauge / 0.9 mm
G-36955 20 gauge / 0.9 mm



CLEANING ADAPTER

for rotatable and
interchangeable tips

G-36604

SINGLE-USE
INTERCHANGEABLE SCISSORS
AVAILABLE ON P. 218





CILIA.....	101
CONJUNCTIVA.....	102
SUTURING.....	103
CORNEAL.....	104
TYING.....	105
FIXATION.....	109
IRIS.....	110
CAPSULORHEXIS.....	113
IOL.....	121
MUSCLE.....	126
VITREORETINAL.....	129
CHALAZION.....	134
MOSQUITO.....	135
SERREFINES · TOWEL CLAMPS.....	136

G-18720 *HENRY*
CILIA FORCEPS
straight jaws
smooth, blunt, squared tips
overall length 100 mm



G-18730 *GRADLE*
CILIA FORCEPS
curved jaws
smooth, blunt, squared tips
overall length 98 mm



G-18750 *BARRAQUER*
CILIA FORCEPS
lightly angled
6.5 mm platform
overall length 109 mm



G-18740 *BEER*
CILIA FORCEPS
3 mm platform
rounded tips 4.5 mm wide
overall length 78 mm



G-18850 *SHAAF*
CILIA AND FOREIGN BODY FORCEPS
grooved tips
curved and pointed
finger grip handle
overall length 96 mm



G-31620 *BARRAQUER*
CILIA AND SUTURE FORCEPS
grooved tips, 7.0 mm platform
curved and pointed
finger grip handle
overall length 112 mm



G-32740 *HAMBURG MODEL*
CILIA AND FOREIGN BODY FORCEPS
tapered fine tips
overall length 90 mm



G-31230

KREFELD MODEL
CONJUNCTIVA FORCEPS
 standard
 1 x 2 teeth
 overall length 100 mm

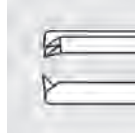

G-31235

FREIBURG MODEL
CONJUNCTIVA FORCEPS
 delicate
 1 x 2 teeth
 overall length 90 mm

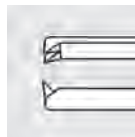

G-18847

KAUFMANN
CONJUNCTIVA FORCEPS
 standard
 1 x 2 teeth
 5 mm tying platform
 overall length 75mm

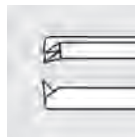

G-18810

DRAEGER
CONJUNCTIVA FORCEPS
 1.2 mm wide
 2 atraumatic fixation knobs
 overall length 97 mm



G-18848

FOERSTER
CONJUNCTIVA FORCEPS
 delicate
 1 x 2 teeth
 finger grip handle
 overall length 95 mm

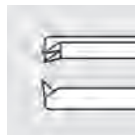



CASTROVIEJO

SUTURING FORCEPS

1 x 2 teeth
6 mm tying platform
overall length 100 mm



G-19001

0.28 mm, teeth 0.12 mm

G-19005

0.3 mm

G-19010

0.6 mm

G-19015

0.9 mm

G-19020

1.2 mm



CASTROVIEJO

SUTURING FORCEPS

new model
1 x 2 teeth
6 mm tying platform
overall length 109 mm

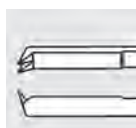

G-19022

0.25 mm, teeth 0.12 mm

G-19023

0.3 mm

G-19024

0.6 mm

G-19025

0.9 mm

G-19026

1.2 mm



G-19008

MUNICH MODEL

SUTURING FORCEPS

1 x 2 teeth, 0.35 mm
5.5 mm tapered tying platform
overall length 100 mm

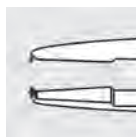

ZUERICH MODEL
SUTURING FORCEPS
delicate

1 x 2 teeth, 0.12 mm
5 mm tying platform
overall length 75 mm

G-18965

G-18966

straight

angled



G-18950

COLIBRI FORCEPS

1 x 2 teeth, 0.12 mm
5 mm tying platform
overall length 75 mm



G-18960

MICRO COLIBRI FORCEPS

delicate
1 x 2 teeth, 0.12 mm
5 mm tying platform
overall length 77 mm



G-15134

MICRO COLIBRI FORCEPS

extra delicate
1 x 2 teeth, 0.12 mm
4 mm tying platform
overall length 76 mm



G-18975

BARRAQUER
SUTURE REMOVING FORCEPS

very fine pointed tips
4 mm tying platform
overall length 77 mm



G-18972

THOMAS NEUHANN
KERATOPLASTY FORCEPS
for corneal suturing and fixation
two prongs with 1 x 2 teeth
0.8 mm prong spread
overall length 80mm



G-18970

REMKY

KERATOPLASTY FORCEPS

two prongs with 1 x 1 teeth, angled
1.7 mm prong spread
for corneal suturing and fixation
overall length 80 mm



G-38623

REMKY

DMEK KERATOPLASTY FORCEPS

modified by *SZURMAN*
two prongs with 1 x 1 teeth, straight
1.7 mm prong spread
33 mm shafts
to hold graft during preparation
overall length 89 mm

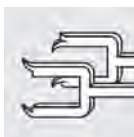

G-18940

PAUFIQUE

UNIVERSAL SUTURING FORCEPS

1 x 2 teeth
6 mm tying platform
overall length 88 mm

G-18945

standard
delicate

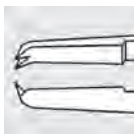

G-19045

PAUFIQUE

TYING FORCEPS

with platform
overall length 88 mm

G-19046

standard, 6 mm platform
delicate, 5 mm platform

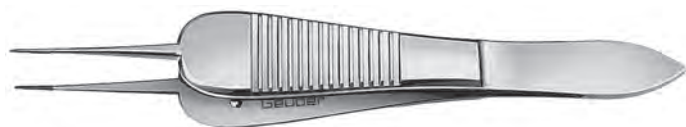
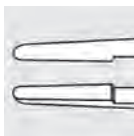

G-19030

TUEBINGEN MODEL

TYING FORCEPS

straight, smooth jaws

6 mm tying platform

overall length 101 mm

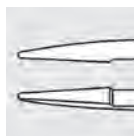

G-19040

TUEBINGEN MODEL

TYING FORCEPS

curved, smooth jaws

6 mm tying platform

overall length 99 mm



G-19035

TUEBINGEN MODEL

TYING FORCEPS

delicate, smooth jaws

4 mm tying platform

overall length 84mm

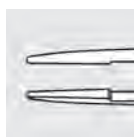

G-19034

BONN MODEL

TYING FORCEPS

extra delicate, smooth jaws

3 mm tying platform

overall length 73 mm



10

TYING

G-19032 **TYING FORCEPS**
angled, 7.5 mm
6 mm tying platform
overall length 99 mm



G-31625 *DARDENNE*
TYING FORCEPS
angled, 6.5 mm
6 mm tying platform
round handle with guide pin
overall length 102 mm

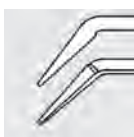

G-19038 *BANGERTER*
TYING FORCEPS
9.5 mm platform
longitudinal v-shape groove
overall length 100 mm



G-19048 **TYING FORCEPS**
utility serrated jaws
1 mm wide
overall length 106 mm



10
TYING

G-32947

HATTENBACH
HYBRID TYING FORCEPS
 angled, for the anterior chamber
 intraocular 1.5 mm micro tying tips
 25 gauge / 0.5 mm
 overall length 98 mm

for use in combination with
 hybrid needle holder G-32949



G-31623

KELMAN-MCPHERSON
FRAGMENT FORCEPS
 angled, smooth jaws
 7.5 mm platform
 overall length 100 mm



G-33941

KELMAN-MCPHERSON
FRAGMENT FORCEPS
 angled, fine grooved jaws,
 for femto-LASIK to retrieve lenticule
 during SMILE procedures
 7.5 mm platform
 overall length 100 mm



G-31622

GASKIN
FRAGMENT FORCEPS
 angled
 with tying platform
 9 mm platform, overall length 107 mm

G-31624

11 mm platform, overall length 100 mm



10

TYING · IRIS SUTURE · FRAGMENT

G-37700 **JEWELERS TYPE FORCEPS**
standard, straight
overall length 120 mm



G-37705 **JEWELERS TYPE FORCEPS**
delicate, straight
overall length 115 mm



G-37710 **JEWELERS TYPE FORCEPS**
extra delicate, straight
overall length 115 mm



G-19080 *BARRAQUER*
FIXATION FORCEPS
3 sets of 1 x 2 teeth
11 mm fixation platform
overall length 100 mm



GRAEFE
FIXATION FORCEPS
4.5 mm wide
8 interlocking teeth
overall length 110 mm
G-19050 without lock
G-19055 with lock



G-19060 *HEIDELBERG MODEL*
FIXATION FORCEPS
3.5 mm wide
6 interlocking teeth
overall length 110 mm



DRESSING FORCEPS

serrated jaws
overall length 100 mm

- G-18780 0.5 mm
- G-18781 0.7 mm
- G-18782 1.0 mm
- G-18783 1.2 mm
- G-18784 1.4 mm

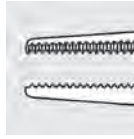

TISSUE FORCEPS

1 x 2 teeth
overall length 100 mm

- G-18790 0.5 mm
- G-18791 0.7 mm
- G-18792 1.0 mm
- G-18793 1.2 mm
- G-18794 1.4 mm

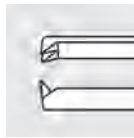

IRIS FORCEPS

serrated, delicate
overall length 73 mm
straight
curved

- G-18855 straight
- G-18856 curved



BONN MODEL

IRIS FORCEPS

serrated, extra delicate
overall length 73 mm
straight
angled at 6 mm
angled at 8 mm

- G-18908 straight
- G-18906 angled at 6 mm
- G-18911 angled at 8 mm

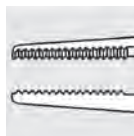

BONN MODEL

IRIS FORCEPS

1 x 2 teeth, 0.12 mm
extra delicate
overall length 73mm
straight
angled at 6 mm
angled at 8 mm

- G-18900 straight
- G-18905 angled at 6 mm
- G-18910 angled at 8 mm



BONN MODEL

IRIS FORCEPS

long, straight
1 x 2 teeth, 0.12 mm
overall length 102 mm

G-18845

extra delicate

G-18890

delicate, with 4.5 mm tying platform

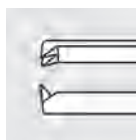

G-18840

SWISS MODEL

IRIS FORCEPS

curved, 1 x 2 teeth
overall length 100 mm



G-18860

HEIDELBERG MODEL

IRIS FORCEPS

light curve, 1 x 2 teeth
overall length 72 mm



G-18870

HEIDELBERG MODEL

IRIS FORCEPS

strong curve, 1 x 2 teeth
overall length 70 mm



G-18857

IRIS FORCEPS

straight, delicate
1 x 2 teeth
overall length 72 mm

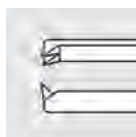

G-31953

IRIS FORCEPS

straight, strong
1 x 2 teeth
overall length 72 mm

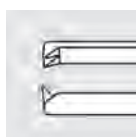

G-18846

HAMBURG MODEL

IRIS FORCEPS

straight, delicate

1 x 2 teeth

overall length 103 mm

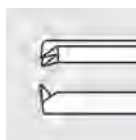

G-32240

SWISS MODEL

IRIS FORCEPS

straight, extra delicate

1 x 2 teeth

overall length 70 mm

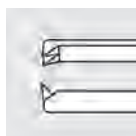

G-18880

HESS-ENGELKING

IRIS FORCEPS

1 x 2 teeth

overall length 72 mm

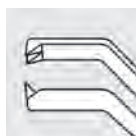

10

IRIS FIXATION

G-18897

ELZE

IRIS FORCEPS

extra delicate

1 x 2 teeth

overall length 78 mm



G-18913

THOMAS NEUHANN

IRIS FORCEPS

curved shaft

1 x 2 teeth

23 gauge / 0.6 mm

overall length 95 mm



G-31307

CAPSULORHEXIS FORCEPS

strong, with heel stop to protect the iris
interlocking micro serrated tips
12 mm straight shafts
overall length 103 mm



G-31308

CAPSULORHEXIS FORCEPS

round handle with guide pin
extra delicate with
interlocking micro serrated tips
13 mm curved shafts
overall length 105 mm



G-31300

MASKET

CAPSULORHEXIS FORCEPS

delicate, with heel stop to protect the iris
interlocking micro serrated tips
12 mm curved shafts
overall length 103 mm



G-31304

CAPSULORHEXIS FORCEPS

new model, with guide pin
extra delicate with
interlocking micro serrated tips
13 mm curved shafts
overall length 103 mm



G-31301

CAPSULORHEXIS FORCEPS

extra delicate
with smooth triangular grasping tips
13 mm curved shafts
overall length 98 mm



G-31305

CAPSULORHEXIS FORCEPS

extra delicate with
interlocking micro serrated tips
13 mm curved shafts
overall length 98 mm



10

CAPSULORHEXIS

G-31303

H.-R. KOCH
CAPSULORHEXIS FORCEPS

extra delicate with
interlocking micro serrated tips
13 mm curved shafts
1 mm marks from tip to bent
overall length 98 mm



G-31299

CAPSULORHEXIS FORCEPS

short handle, extra delicate
cross serrated grasping tips
12 mm straight shafts
overall length 83 mm



G-32926

AUFFARTH

MICS DOUBLE CROSS ACTION CAPSULORHEXIS FORCEPS

interlocking micro serrated tips
12 mm curved shafts, angled 130°
with overlap system
prevents inadvertent iris capture
for 1.6 mm incisions
overall length 100 mm



G-32928

INAMURA

MICS CAPSULORHEXIS FORCEPS

cross action
interlocking micro serrated tips
10.5 mm curved shafts tip to pivot
angled 130°
overall length 103 mm



G-31306

KAMPIK

MICS CAPSULORHEXIS FORCEPS

22 gauge / 0.7 mm curved shaft
90° cystotome tips, reverse action
overall length 93 mm



G-32935

H.-R. KOCH

MICS CAPSULE FORCEPS

short handle
22 gauge / 0.7 mm curved shaft with
micro grasping tips
overall length 98 mm





G-32938 *H.-R. KOCH*
MICS CAPSULE FORCEPS
 22 gauge / 0.7 mm curved shaft with micro grasping tips
 6 mm titanium handle, blue-colored
 overall length 144 mm



G-32936 *TOBIAS NEUHANN*
MICRO FORCEPS
 multifunction asymmetrical tips with grasping platform
 23 gauge / 0.6 mm straight shaft
 6 mm titanium handle, blue-colored
 overall length 155 mm



G-32937 *IKEDA*
MICS CAPSULORHEXIS FORCEPS
 23 gauge / 0.6 mm curved shaft with micro grasping tips
 6 mm titanium handle, blue-colored
 overall length 144 mm



IKEDA
CAPSULORHEXIS FORCEPS
 interchangeable tips
 23 gauge / 0.6 mm curved shaft
 overall length 40 mm

G-38244 textured, micrograsping tips "BEAK"
G-38242 textured, micrograsping tips



G-38244
 "beak"

G-38242



for use with handle G-38240

G-38240 *JAPAN MODEL*
HANDLE
 for capsule scissors and forceps
 interchangeable tips
 6 mm, titanium
 overall length 90 mm



G-32944

HATTENBACH

CAPSULORHEXIS FORCEPS

25 gauge / 0.5 mm angled shaft with
micro grasping tips
overall length 88 mm



G-18805

TOBIAS NEUHANN

DESCEMET MEMBRANE FORCEPS

delicate blunt grasping tips
with platform
overall length 75 mm



G-38624

SZURMAN

DMEK PREPARATION FORCEPS

for removal of Descemet layer
with smooth round tips to prevent tearing
the donor endothelium
overall length 75 mm



G-38628

YÖRÜK

DMEK TRANSPLANT FORCEPS

atraumatic grasping and removal of
Descemet's membrane
grasping area 6 mm
overall length 77 mm



G-38634

GERTEN

DSAEK/DMEK RHEXIS FORCEPS

for Descemetorhexis
reversed triangular tips to
score and remove the DM from the host cornea
23 gauge / 0.6 mm curved shaft
overall length 142 mm



G-38603

DSAEK IMPLANTATION FORCEPS

13 mm curved shafts with limited closing
to avoid injury of endothelial transplant
1.5 mm serrated platform
overall length 107 mm



G-38606

THOMAS NEUHANN
DSAEK FORCEPS

1 x 2 teeth, 0.12 mm
21 gauge / 0.8 mm curved shaft
for endothelial transplant procedures
overall length 97 mm



G-33428

PFAEFFL
FLAPORHEXIS FORCEPS

2.5 mm x 1.5 mm cross serrated tips, oval
to lift femto-LASIK flaps
overall length 103 mm



G-33429

KNORZ
FEMTO-LASIK FLAP FORCEPS

curved 3.25 mm T-bar
textured
to grasp and lift LASIK flaps
overall length 102 mm





G-31899 **LASIK CORNEAL FLAP FORCEPS**
angled shafts, 9 mm
highly polished round and smooth shafts
overall length 108 mm

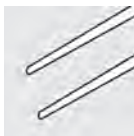

G-18914 *BURATTO*
LASIK CORNEAL FLAP FORCEPS
curved shafts
cross serrated tips, 0.8 mm diameter
overall length 100 mm



G-33960 *RUPAL SHAH*
LENTICULE FORCEPS
3.5 mm serrated tips
20 gauge / 0.9 mm curved shaft
to retrieve lenticule during SMILE procedures
6 mm titanium handle, blue-colored
overall length 144 mm



G-33961 **LENTICULE FORCEPS**
7.5 mm shafts
with fine grooves
angled to side
to retrieve lenticule during SMILE procedures
overall length 99 mm





G-31518 **NUCLEUS SPREADING FORCEPS**
 cross-action
 3.0 mm textured paddle tips
 for cracking the nucleus
 overall length 112 mm



G-31519 *AKAHOSHI*
NUCLEUS SPREADING FORCEPS
 phaco prechopper
 4.5 mm delicate sharp tips, 1 mm profile
 2.0 mm cross-action
 for cracking, dividing, and rotating the nucleus
 overall length 105 mm



G-31720 *AKAHOSHI*
PRECHOPPER
 for micro-incisions, straight shafts, cross action
 round handle
 overall length 125 mm



G-31722 *AKAHOSHI*
HYBRID COMBO PRECHOPPER
 for micro-incisions, cross action, straight
 round handle
 length of tip 5.3 mm
 overall length 120 mm





G-31724 *AKAHOSHI*
UNIVERSAL PRECHOPPER
for micro-incisions, cross action, straight
round handle
overall length 120 mm



G-33440 *VON BARSEWISCH*
ANTERIOR CHAMBER FORCEPS
extra delicate
8.5 mm angled shafts
1.5 mm platform
overall length 72 mm



G-32165 *FECHNER*
IMPLANTATION FORCEPS
smooth curved shafts
overall length 80 mm



G-18935 *DODEN*
IMPLANTATION FORCEPS
curved
delicate lens holding shafts
overall length 110 mm





G-18930 *SHEPARD*
IMPLANTATION FORCEPS
 curved, 1.4 mm disc-shaped tips
 delicate lens holding shafts
 overall length 120 mm



G-31962 *T. KOHNEN*
IMPLANTATION FORCEPS
 silicone tube coated
 10 mm angled shafts
 overall length 107 mm

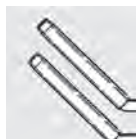

G-18918 *DICK*
FIXATION AND HOLDING FORCEPS
 for Artisan/Verisyse IOL
 with guide mark for lens maximum hold
 and stability
 18 gauge / 1.2 mm curved shaft
 overall length 143



G-18919 *DICK*
IOL HAPTIC EXPANDER
 for enclavation of iris-fixated IOLs
 21 gauge / 0.8 mm curved shaft
 overall length 140 mm



10

IOL IMPLANTATION · SILICONE COATED



G-18944

T. NEUHANN

IMPLANTATION FORCEPS

for retropupillary implantation of Iris-Claw-IOL
0.9 mm wide holding surface
20 gauge / 0.9 mm curved shaft
overall length 143 mm

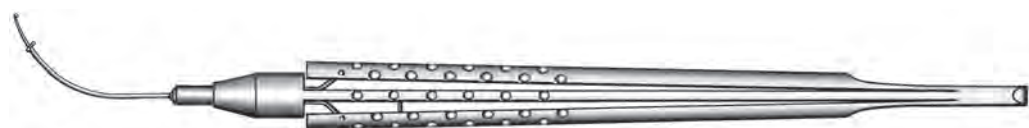

G-18928

SEKUNDO

IMPLANTATION FORCEPS

for retropupillary implantation of Iris-Claw-IOL
20 gauge / 0.9 mm curved shaft with
lens holding plate, three-point fixation
and IOL centration guide mark
6 mm titanium handle, blue-colored
overall length 143 mm



G-31902

FOLDER

foldable IOL insertion forceps
cross action
6.5 mm concave jaws
overall length 103 mm



G-31903

SPALECK

FOLDER

foldable IOL insertion forceps
for silicone and acrylic IOLs
angled shafts, concave jaws
overall length 102 mm



G-31908

FOLDER

IOL folding forceps
for easy pickup and folding acrylic IOLs
overall length 105 mm



G-31994

H.-R. KOCH
PREFOLDER

for foldable silicone, hydrogel or acrylic IOLs
overall length 135 mm



10

IOL FOLDERS · IOL HOLDERS

G-31905

H.-R. KOCH
FOLDER

for foldable 3-piece IOLs
6.0 mm concave jaws
overall length 92 mm



G-31901

HOLDING FORCEPS

for foldable IOLs
highly polished round and smooth shafts
overall length 108 mm



G-18941

STROBEL
HOLDING FORCEPS
for Pharmacia CeeOn Edge IOL
overall length 110 mm

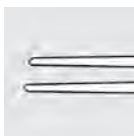

G-32823

EXPLANTATION FORCEPS
for soft IOLs
2.0 mm x 1.4 mm paddle tip with
interlocking serrations and guide pin
overall length 108 mm



G-32997

SNYDER-OSHER
IOL FORCEPS
to hold the IOL while cutting it inside
the capsular bag
2 mm long jaws with 0.5 mm serrated tips
22 gauge / 0.7 mm lightly curved shaft
overall length 99 mm



G-18820

REMKY
SUPERIOR RECTUS FORCEPS
angled
1 x 2 teeth
overall length 109 mm

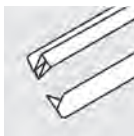

G-18800

ELSCHNIG
SUPERIOR RECTUS FORCEPS
 standard, straight
 1 x 2 teeth
 overall length 110 mm

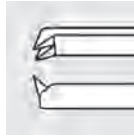

G-18795

ELSCHNIG
SUPERIOR RECTUS FORCEPS
 delicate, straight
 1 x 2 teeth
 overall length 100 mm

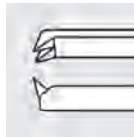

G-19105

LEYDHECKER
SUPERIOR RECTUS FORCEPS
 curved, tip width 0.8 mm
 1 x 2 teeth, 1.1 mm
 overall length 110 mm

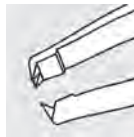

G-32335

CASTROVIEJO
SUPERIOR RECTUS FORCEPS
 angled with tying platform
 1 x 2 teeth, 0.9 mm
 overall length 100 mm

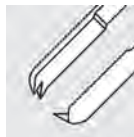

G-19112

BANGERTER
MUSCLE FORCEPS
 10 teeth
 self retaining
 overall length 100 mm



SATTLER

MUSCLE FORCEPS

with slide lock
overall length 100 mm

G-19120

3 teeth, bulbous tip, right

G-19125

3 teeth, bulbous tip, left



G-32350

TROELTSCH

NASAL FORCEPS

serrated tips
for packing and dressing during ENT procedures
overall length 150 mm



G-19107

ESSEN MODEL

CERCLAGE FORCEPS

strongly curved
3 mm platform with dual grooves
overall length 104 mm



G-33752

WATZKE

SPREADING FORCEPS

to stretch silicone sleeves
cross action handle and serrated tips
overall length 115 mm



G-33434

PFENNIGWERTH

HOLDING FORCEPS

for vitreoretinal lenses
curved with concave lens holding tips
overall length 110 mm



G-33439

SCLERAL PLUG FORCEPS

cross action handle, angled jaws to securely hold plugs during insertion and removal
overall length 105 mm



G-31570

SCLERAL PLUG FORCEPS

to securely hold plugs during insertion and removal
overall length 100 mm



10

RETINAL (SCLERAL PLUG, RETINAL TACK)



G-33432 SCLERAL PLUG
serrated,
20 gauge / 0.9 mm



G-33436 SCLERAL PLUG
to suture onto sclera
20 gauge / 0.9 mm



G-33435 SCLERAL PLUG
20 gauge / 0.9 mm



G-33441 SCLERAL PLUG
23 gauge / 0.6 mm

G-33438

FORCEPS

for HEIMANN retinal tacks
overall length 100 mm



G-33437T

HEIMANN RETINAL TACK

titanium
- for single use only -

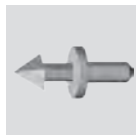

G-37420 *BARTZ-SCHMIDT*
TROCAR CLOSURE FORCEPS
with function for bulbus fixation
overall length 72 mm



G-37430 **TROCAR FORCEPS**
for trocar systems with groove
overall length 110 mm



G-33831 *REIMANN*
VITREORETINAL FORCEPS
for foreign body removal
with retractable magnet and 3-prongs
14 gauge / 2.1 mm straight shaft
shaft length 35 mm
overall length 138 mm

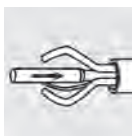

20 GAUGE

VITREORETINAL FORCEPS

20 gauge / 0.9 mm
 6 mm and 8 mm diameter handles
 titanium, blue-colored
 overall length 155 mm

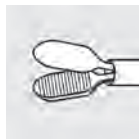

straight
 serrated tips
G-36202 6 mm handle

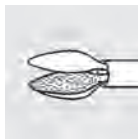

straight
 textured tips
G-36206 6 mm handle
G-36208 8 mm handle

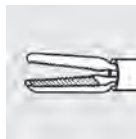

straight
 serrated "crocodile" tips
G-36256 6 mm handle
G-36258 8 mm handle

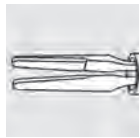

straight
 silicone coated
G-36212 6 mm handle
G-36214 8 mm handle

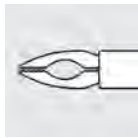

TANO
 straight, serrated tips
G-36356 6 mm handle
G-36358 8 mm handle

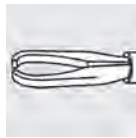

A. MUELLER
 for retinal vessels / sheatotomy
G-36332 6 mm handle

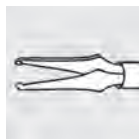

straight
 grip tips
G-36216 6 mm handle
G-36218 8 mm handle

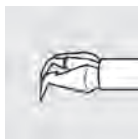

90° angle
 pointed tips
G-36276 6 mm handle
G-36278 8 mm handle



NAITO
 ILM
G-36316 6 mm handle
G-36318 8 mm handle

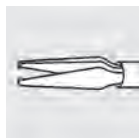

straight
 endgripping, extra delicate
 0.2 mm x 0.05 mm
G-36292 6 mm handle
G-36294 8 mm handle

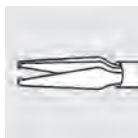

straight
 endgripping, extra delicate
 0.3 mm x 0.05 mm
G-36296 6 mm handle
G-36298 8 mm handle

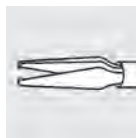

straight
 endgripping, delicate
 0.2 mm x 0.1 mm
G-36302 6 mm handle
G-36304 8 mm handle

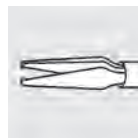

straight
 endgripping
 0.3 mm x 0.1 mm
G-36306 6 mm handle
G-36308 8 mm handle



10

VITREORETINAL 20 GAUGE

20 GAUGE

VITREORETINAL FORCEPS

20 gauge / 0.9 mm
6 mm and 8 mm diameter handles
titanium, blue-colored
overall length 155 mm



90° angle
membrane peeler
G-36226 6 mm handle

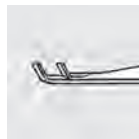

45° angle
membrane peeler
G-36232 6 mm handle



45° angle
G-36222 6 mm handle



membrane peeler tips
G-36252 6 mm handle
G-36254 8 mm handle



curved
membrane dissector
G-36266 6 mm handle



45° angle
membrane dissector
G-36272 6 mm handle

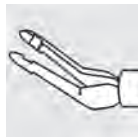

45° angle
horizontal subretinal
G-36236 6 mm handle



45° angle, vertical tips
subretinal
G-36246 6 mm handle
G-36248 8 mm handle



angled, extra delicate
3.0 mm tips
G-36336 6 mm handle



angled, extra delicate
4.5 mm tips
G-36326 6 mm handle
G-36328 8 mm handle



straight
circular tips
G-36242 6 mm handle

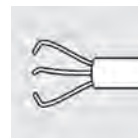

foreign body forceps
G-36262 6 mm handle
G-36264 8 mm handle

23 GAUGE

VITREORETINAL FORCEPS

23 gauge / 0.6 mm
6 mm and 8 mm diameter handles
titanium, blue-colored
overall length 155 mm

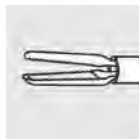

straight
serrated "crocodile" tips

G-36342 6 mm handle
G-36344 8 mm handle

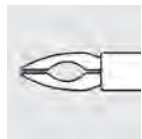

TANO
straight, serrated tips

G-36362 6 mm handle
G-36364 8 mm handle



straight
endgripping, extra delicate
0.2 mm x 0.05 mm

G-36282 6 mm handle
G-36284 8 mm handle

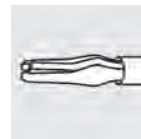

straight
grip tips

G-36286 6 mm handle
G-36288 8 mm handle

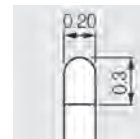

25 GAUGE

VITREORETINAL FORCEPS

25 gauge / 0.5 mm
6 mm and 8 mm diameter handles
titanium, blue-colored
overall length 155 mm

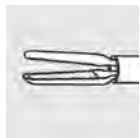

straight
serrated "crocodile" tips

G-36322 6 mm handle
G-36324 8 mm handle

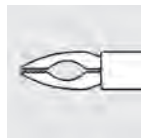

TANO
straight, serrated tips

G-36366 6 mm handle
G-36368 8 mm handle



straight
endgripping, extra delicate
0.2 mm x 0.05 mm

G-36312 6 mm handle
G-36314 8 mm handle



ERGOLINE

ERGOLINE FORCEPS

360° rotatable and interchangeable tips
overall length 55 mm
for Ergoline handpieces 6 mm and 8 mm diameters

ERGOLINE HANDPIECE

for Ergoline forceps
blue-colored
G-36600 6 mm titanium handpiece
G-36601 8 mm titanium handpiece

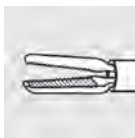

ERGOLINE FORCEPS
straight
serrated "crocodile" tips
G-36655 20 gauge / 0.9 mm
G-36740 23 gauge / 0.6 mm
G-36720 25 gauge / 0.5 mm

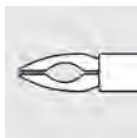

TANO
ERGOLINE FORCEPS
straight, serrated tips
G-36755 20 gauge / 0.9 mm
G-36765 23 gauge / 0.6 mm



NAITO
ERGOLINE FORCEPS ILM
G-36715 20 gauge / 0.9 mm

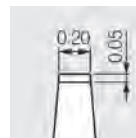
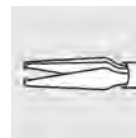

ERGOLINE FORCEPS
endgripping
extra delicate 0.2 mm x 0.05 mm
G-36690 20 gauge / 0.9 mm
G-36680 23 gauge / 0.6 mm
G-36710 25 gauge / 0.5 mm

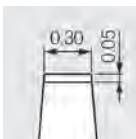
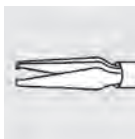

ERGOLINE FORCEPS
endgripping
extra delicate 0.3 mm x 0.05 mm
G-36695 20 gauge / 0.9 mm

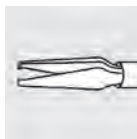

ERGOLINE FORCEPS
endgripping
delicate 0.2 mm x 0.1 mm
G-36700 20 gauge / 0.9 mm

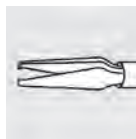

ERGOLINE FORCEPS
endgripping
delicate 0.3 mm x 0.1 mm
G-36705 20 gauge / 0.9 mm

SINGLE-USE
INTERCHANGEABLE FORCEPS
AVAILABLE ON P. 219



10
VITREORETINAL · INTERCHANGEABLE · ROTATABLE

G-18680 *LAMBERT*
CHALAZION FORCEPS
 round, 9 mm inside diameter
 solid and fenestrated plates
 overall length 92 mm



G-18670 *AYER*
CHALAZION FORCEPS
 round, 8 mm inside diameter
 interlacing tips
 solid and fenestrated plates
 overall length 90 mm



DESMARRES
CHALAZION FORCEPS
 oval
 solid and fenestrated plates
G-18685 20 mm, overall length 88 mm
G-18690 25 mm, overall length 90 mm
G-18695 31 mm, overall length 95 mm



G-18700 *CAUER*
CHALAZION FORCEPS
 oval, 13 mm x 11 mm inside diameter
 interlacing serrated tips
 solid and fenestrated plates
 overall length 99 mm



G-18710 *LORDAN*
CHALAZION FORCEPS
 triangular, 13 mm x 8 mm inside diameter
 solid and fenestrated plates
 overall length 95 mm



G-18715 *BERKE*
PTOSIS FORCEPS
 22 mm long serrated tips
 slide lock mechanism
 overall length 110 mm



HARTMANN
MOSQUITO FORCEPS
serrated
18 mm jaws
overall length 100 mm
straight
G-18170
G-18171 curved



HALSTEAD
MOSQUITO FORCEPS
serrated
25 mm jaws
overall length 125 mm
straight
G-18180
G-18181 curved

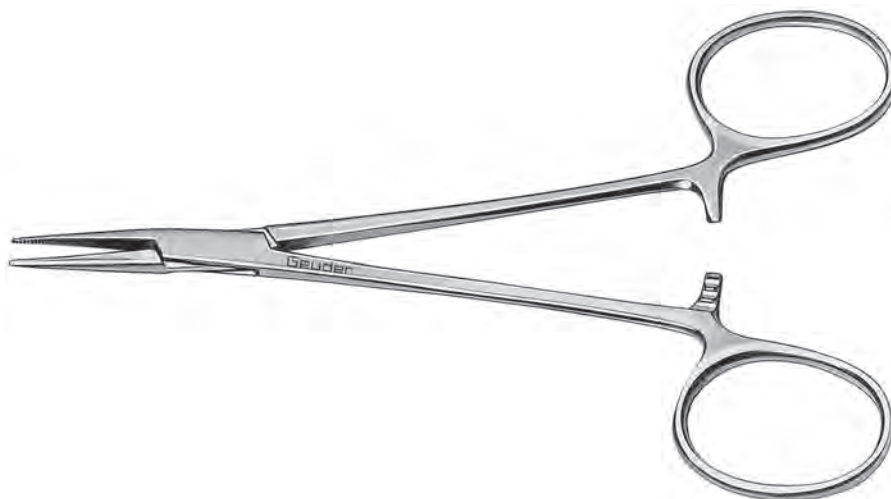

HALSTEAD
MOSQUITO FORCEPS
1 x 2 teeth
serrated
25 mm jaws
overall length 125 mm
straight
G-18185
G-18182 curved





G-18160 *BACKHAUS*
TOWEL FORCEPS
overall length 90 mm



G-33200 *SCHAEDEL*
TOWEL FORCEPS
overall length 90 mm



G-18190 *DIEFFENBACH*
SERREFINE
straight, overall length 35 mm



G-18195 *DIEFFENBACH*
SERREFINE
curved, overall length 35 mm



G-31420 *DIEFFENBACH*
SERREFINE
straight, overall length 50 mm



G-31415 *DIEFFENBACH*
SERREFINE
curved, overall length 50 mm



G-18197 **SERREFINE**
extra delicate, overall length 30 mm

NEEDLE HOLDERS



*BARRAQUER***NEEDLE HOLDER**

10 mm delicate jaws
0.8 x 0.55 mm tip
overall length 120 mm
curved, without lock
curved, with lock

G-17500
G-17501

*BARRAQUER***NEEDLE HOLDER**

10 mm delicate jaws
0.8 x 0.45 mm tip
overall length 120 mm
curved, without lock
curved, with lock

G-17505
G-17506

*JACOBI***NEEDLE HOLDER**

5 mm extra delicate jaws
1.0 x 0.5 mm tips
overall length 115 mm
straight, without lock
straight, with lock

G-17451
G-17453

*JACOBI***NEEDLE HOLDER**

5 mm extra delicate jaws
1.0 x 0.5 mm tips
overall length 115 mm
curved, without lock
curved, with lock

G-17450
G-17452

*BARRAQUER***NEEDLE HOLDER**

7.5 mm extra delicate jaws
0.6 x 0.3 mm tip
overall length 105 mm
straight, without lock
straight, with lock

G-17461
G-17463

*BARRAQUER***NEEDLE HOLDER**

7.5 mm extra delicate jaws
0.6 x 0.3 mm tip
overall length 105 mm
curved, without lock
curved, with lock

G-17460
G-17462



BARRAQUER-TROUTMAN
NEEDLE HOLDER

10 mm extra delicate jaws
0.8 x 0.6 mm tip
handle diameter 6 mm
overall length 100 mm
straight, without lock
straight, with lock

G-32260
G-32261



BARRAQUER-TROUTMAN
NEEDLE HOLDER

10 mm extra delicate jaws
0.8 x 0.6 mm tip
handle diameter 6 mm
overall length 100 mm
curved, without lock
curved, with lock

G-17535
G-17530



BARRAQUER
NEEDLE HOLDER

11 mm delicate jaws
0.9 x 0.8 mm tips
handle diameter 8 mm
overall length 140 mm
curved, without lock
curved, with lock

G-17510
G-17511



BARRAQUER
NEEDLE HOLDER

11 mm extra delicate jaws
0.9 x 0.55 mm tips
handle diameter 8 mm
overall length 140 mm
curved, without lock
curved, with lock

G-17515
G-17516



*BARRAQUER***NEEDLE HOLDER**

11 mm delicate jaws
1.1 x 0.75 mm tips
handle diameter 10 mm
overall length 140 mm
curved, without lock
curved, with lock

G-17520**G-17525****G-32315***BARRAQUER***NEEDLE HOLDER**

curved, without lock
8 mm standard jaws
1.2 x 0.8 mm tips
original model with longitudinal groove
handle diameter 10 mm
overall length 130 mm

**G-32320****G-32321***BARRAQUER***NEEDLE HOLDER**

12 mm standard jaws
1.6 x 1.0 mm tips
handle diameter 10 mm
overall length 140 mm
curved, without lock
curved, with lock

CASTROVIEJO
NEEDLE HOLDER

short model
9 mm extra delicate jaws
0.9 x 0.55 mm tips
overall length 90 mm
straight, without lock
straight, with lock

G-17545
G-17540



CASTROVIEJO
NEEDLE HOLDER

10.5 mm delicate jaws
1.5 x 0.8 mm tips
overall length 140 mm
straight, without lock
straight, with lock

G-17560
G-17565



CASTROVIEJO
NEEDLE HOLDER

10.5 mm delicate jaws
1.5 x 0.8 mm tips
overall length 140 mm
curved, without lock
curved, with lock

G-17570
G-17575



COMBINED NEEDLE HOLDER / SCISSORS
curved 12 mm blades with
3 mm needle holder and tying platform
used to hold, place and cut fine suture material
overall length 125 mm



G-17440

without lock

G-17441

with lock



G-32949

HATTENBACH

HYBRID NEEDLE HOLDER

angled, for the anterior chamber
25 gauge / 0.5 mm
overall length 90 mm



for use in combination with
hybrid tying forceps G-32947



KALT
NEEDLE HOLDER

standard jaws
serrated, with longitudinal groove
thumb rest and catch
overall length 135 mm

G-17610

straight, cross serrated jaws

G-17615

curved, cross serrated jaws



ARRUGA
NEEDLE HOLDER
 14 mm heavy jaws
 thumb rest and catch
 overall length 140 mm
 straight, smooth jaws
 curved, smooth jaws

G-17640
G-17645

G-17660 *HEIDELBERG MODEL*
NEEDLE HOLDER
 straight
 14 mm heavy jaws
 with ratchet lock
 overall length 125 mm



G-17650 *BOYNTON*
NEEDLE HOLDER
 straight
 with ratchet lock
 overall length 120 mm



G-17665 *ROHRSCHEIDER*
NEEDLE HOLDER
 straight
 13 mm heavy jaws
 1.3 x 1.5 mm tips
 overall length 100 mm

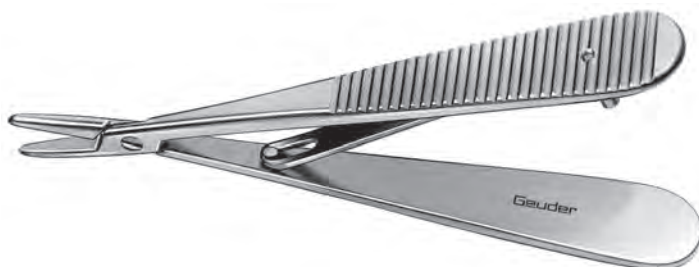

NEEDLE HOLDERS

11

- G-19270** *BARRAQUER*
RAZOR BLADE HOLDER
flat handle
overall length 110 mm



- G-19320** *CASTROVIEJO*
RAZOR BLADE HOLDER
6 mm round handle
overall length 120 mm



- G-19330** *TROUTMAN*
RAZOR BLADE HOLDER
straight
6 mm round handle
overall length 95 mm



- G-19300** **RAZOR BLADES**
10 pcs. per box



- G-18150** **HOLDER FOR ABSORBENT STRIPS**
serrated
to secure sterile absorbent swabs (G-18127)
overall length 175 mm

MANIPULATORS CHOPPERS, FIXATION RINGS HOOKS, SPATULAS LENS LOOPS



FIXATION RINGS	149
NUCLEUS CHOPPERS	151
LENS & NUCLEUS MANIPULATORS	155
IRIS HOOKS	157
NUCLEUS SPATULAS	158
CAPSULE POLISHERS	160
LENS LOOPS	161
ORBITAL SPATULAS	162
CYCLODIALYSIS SPATULAS	164
IRIS SPATULAS	165
FEMTOSECOND LASER MANIPULATORS	169
STRABISMUS HOOKS	173
MEMBRANE PEELERS AND SPATULAS	175

G-37440

HATTENBACH

GLOBE FIXATION RING

for transconjunctival PPV
12 mm inside diameter



G-33755

THORNTON

FIXATION RING

16 mm inside diameter
12 atraumatic teeth



G-31490

FINE-THORNTON

FIXATION RING

for clear cornea and refractive procedures
16 mm inside diameter, 10 mm opening
12 atraumatic teeth



G-31491

FINE-THORNTON

FIXATION RING

for clear cornea and refractive procedures
13 mm inside diameter, 10 mm opening
9 atraumatic teeth





G-33757 *FINE-THORNTON*
FIXATION RING
for clear cornea and refractive procedures
swivel handle
16 mm inside diameter, 10 mm opening
12 atraumatic teeth



G-33758 *FINE-THORNTON*
FIXATION RING
for clear cornea and refractive procedures
swivel handle
13 mm inside diameter, 10 mm opening
9 atraumatic teeth



G-33759 *FINE-THORNTON*
FIXATION RING
for clear cornea and refractive procedures
swivel handle
13 mm inside diameter, 10 mm opening
9 atraumatic teeth



G-37425 **FIXATION, HOLDING AND
MEASURING INSTRUMENT**
for trocar system, radius 3.5 mm



FLIERINGA
SCLERAL FIXATION RING
G-15065 15 mm
G-15070 16 mm
G-15075 17 mm
G-15080 18 mm
G-15085 19 mm
G-15090 20 mm

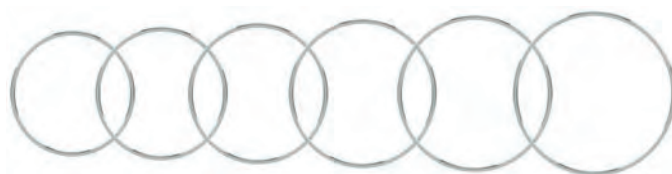

G-32505

THOMAS NEUHANN
NUCLEUS DIVIDING HOOK
for vertical chopping techniques
0.5 mm wide fine tip
overall length 108 mm



G-31500

MIYOSHI
NUCLEUS DIVIDING HOOK
1 mm tip, 0.6 mm inner edge
overall length 104 mm
universal

G-31501

for use in left hand

G-31502

for use in right hand



universal
G-31500



left hand
G-31501



right hand
G-31502

G-31504

VÖLCKER
NUCLEUS DIVIDING HOOK
for narrow pupils
with outer notch to push iris aside
1.5 mm inner edge
overall length 104 mm



G-31503

ZIRM
NUCLEUS DIVIDING HOOK
1.5 mm inner edge
overall length 104 mm



G-32500

TOBIAS NEUHANN

CHOPPER

paddle shape nucleus divider
0.5 mm wide tip
overall length 108 mm



side view



front view

handle

tip

G-32282

AGARWAL

KARATE PHACO CHOPPER

0.9 mm long tip
0.6 mm inner edge
overall length 104 mm



NUCLEUS CHOPPERS

12

G-31505

G-31506

HAEFLIGER

NUCLEUS DIVIDING HOOK

to crack, chop and manipulate lenses
1.0 mm triangular tip
0.7 mm inner sharp hook
overall length 104 mm

for use in right hand

for use in left hand



G-31507

NAGAHARA

NUCLEUS DIVIDING HOOK

for horizontal chopping techniques
1.5 mm long tip
0.9 mm inner edge
overall length 98 mm



G-32501

THOMAS NEUHANN
NUCLEUS ROTATOR and
TOBIAS NEUHANN
CHOPPER

combination of
horizontal Y-shaped nucleus rotator and
paddle shaped nucleus divider
overall length 119 mm



like G-32160



like G-32500

G-32168

THOMAS NEUHANN
SPATULA and
NAGAHARA
NUCLEUS DIVIDING HOOK

combination of
0.5 mm wide phaco spatula and
horizontal phaco chopper
overall length 116 mm



like G-16189



like G-31507

G-32161

THOMAS NEUHANN
NUCLEUS ROTATOR AND DIVIDING HOOK

combination of
horizontal Y-shaped nucleus rotator and
vertical phaco chopper
overall length 117 mm

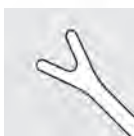

like G-32160



like G-32505

G-32164

THOMAS NEUHANN
SPATULA AND NUCLEUS DIVIDING HOOK

combination of
0.5 mm wide phaco spatula and
vertical phaco chopper
overall length 125 mm



like G-16189



like G-32505

G-32162

THOMAS NEUHANN
IRIS HOOK AND NUCLEUS DIVIDING HOOK
combination of push-pull iris hook and
NEUHANN vertical chopper
overall length 120 mm



like G-16175



like G-32505

G-32169

T. KOHNEN
IRIS HOOK AND NUCLEUS DIVIDING HOOK
combination of push-pull iris hook and
NAGAHARA horizontal chopper
overall length 114 mm



like G-16175



like G-31507

G-16181

G-16182

LIEBERMANN
MICROFINGER
Nucleus Manipulator
1.5 mm curved microfinger
overall length 103 mm
for use in right hand
for use in left hand



G-31727

AKAHOSHI
NUCLEUS SUSTAINER
to manipulate and sustain nucleus
used in combination with prechopper
0.5 mm ball tip
1.8 mm angled
overall length 100 mm



G-16185

DRYSDALE

**NUCLEUS MANIPULATOR AND
ANTERIOR CAPSULE POLISHER**

to manipulate, rotate, and divide the nucleus
1.0 mm x 1.5 mm paddle shaped tip
overall length 100 mm



G-32160

THOMAS NEUHANN

NUCLEUS ROTATOR

horizontal Y-shaped rotator and manipulator
0.15 mm diameter tip
overall length 104 mm



G-32034

HENNIG / FRIEDRICH

LENS EXTRACTION HOOK

(Hefri Hook)
overall length 105 mm



G-32550

MAINZ MODEL

LENS MANIPULATOR

straight
0.15 mm diameter tip
overall length 114 mm



G-32556

MAINZ MODEL

MANIPULATOR

vaulted
0.15 mm diameter tip
overall length 109 mm



JACOBI
LENS MANIPULATOR
vaulted
overall length 99 mm
for 0.3 mm IOL hole
G-16160
G-16161



SINSKEY
LENS MANIPULATION HOOK
for 0.2 mm IOL hole
10 mm angled shaft
overall length 103 mm
flat handle
G-16166
G-16167



G-32557
BREMEN MODEL
LENS MANIPULATOR
vertical Y-hook
0.15 mm diameter tip
overall length 116 mm



G-32555
RENTSCH
LENS MANIPULATOR AND HOOK
straight
0.18 mm diameter boat hook
overall length 137 mm



G-32530
FRANKFURT MODEL
MANIPULATOR
straight
0.18 mm diameter lens hook
overall length 137 mm



IOL MANIPULATORS · POSITION HOOKS

12

G-32275

ZIRM
LENS LOOP MANIPULATOR
vertical Y-hook
0.15 mm diameter tip
overall length 108 mm



G-32276

LESTER
LENS LOOP MANIPULATOR
vaulted
0.25 mm diameter tip
overall length 102 mm



G-16169

TANDOGAN
EXPLANTATION HOOK
for IOL
0.2 mm diameter tip
overall length 103 mm



G-16210

HIRSCHMANN
LENS SPATULA
0.6 mm wide spatula with
0.2 mm notches
overall length 104 mm



G-16175

DARDENNE
IRIS HOOK AND LENS MANIPULATOR
push-pull tip
overall length 105 mm



G-32227

LUND

IRIS HOOK

0.8 mm collar button
overall length 105 mm



G-16205

BONN MODEL

IRIS HOOK

extra delicate
0.15 mm diameter hook
overall length 111 mm

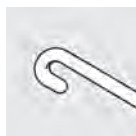

G-31911

FRANKFURT MODEL

IRIS HOOK AND LENS MANIPULATOR

0.65 mm collar button
overall length 135 mm



G-16191

STEINMETZ

SPATULA

for manual lens fragmentation
1 mm wide nucleus bisector
for use in left hand
overall length 110 mm



G-16193

SPIRIG

SPATULA

for manual lens fragmentation
0.5 mm wide nucleus bisector
overall length 110 mm



G-32728

RENTSCH
SPATULA

12 mm long spatula
tapered from 0.6 mm to 0.3 mm
overall length 118 mm



G-32005

ENGELS
PHACO SPOON

0.6 mm wide round spatula
overall length 86 mm



G-32007

D. D. KOCH
PHACO SPATULA

curved with notches
duckbill 0.5mm wide tip
overall length 105 mm



G-32523

AMON
PHACO SPATULA

paddle-shaped tip
0.8 mm wide x 1.6 mm long
0.2 mm thick
overall length 103 mm



G-16189

SPATULA

12 mm spatula
angled, 45°
overall length 108 mm

G-16190

0.5 mm wide x 0.25 mm thick
1.0 mm wide x 0.25 mm thick



G-32724

SEKUNDO
ENCLAVATION SPATULA
for retropupillary implantation of
Iris-Claw IOL
14 mm long spatula
tapered from 0.75 mm to 0.3 mm
overall length 118mm



G-31378

ANIS
BALL CAPSULE POLISHER
1.5 mm diameter hemisphere tip
textured
overall length 113 mm



G-32563

RENTSCH
CAPSULE POLISHING CURETTE
angled 135°
1.5 mm diameter tip
anterior and posterior semi-sharp edges
overall length 108 mm

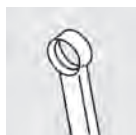

G-32564

RENTSCH
CAPSULE POLISHING CURETTE
angled 90°
1.5 mm diameter tip
anterior and posterior semi-sharp edges
overall length 110 mm



G-15620

ARLT
LENS LOOP
serrated, curved
3.5 mm wide
overall length 135 mm



G-15630

SNELLEN
LENS LOOP
smooth, curved
3.5 mm wide
overall length 135 mm



G-15640

WEBER
LENS LOOP
small
4 mm wide
overall length 130 mm



G-15645

WEBER
LENS LOOP
large
5 mm wide
overall length 135 mm



G-15635

SPIRIG
LENS LOOP
for manual lens fragmentation
serrated, curved
2.2 mm wide
overall length 135 mm





BANGERTER
SPATULA
lightly curved
overall length 139 mm

G-15720

6 mm wide

G-15725

10 mm wide

G-15730

12 mm wide



G-15731

BEHRENS-BAUMANN
ORBITAL SPATULA
with aspiration
10 mm wide, lightly curved
overall length 137 mm



SAUTTER
ORBITAL SPATULA
overall length 142 mm
G-15740 22 x 13 mm curved plate
G-15745 22 x 16 mm curved plate
G-15750 22 x 19 mm curved plate

G-15740

22 x 13 mm curved plate

G-15745

22 x 16 mm curved plate

G-15750

22 x 19 mm curved plate



G-32445

HAMBURG MODEL
ORBITAL SPATULA
18 x 12 mm curved plate
overall length 145 mm

18 x 12 mm curved plate

overall length 145 mm



G-32446 **ORBITAL SPATULA**
18 x 8 mm curved plate
overall length 145 mm



G-15758 **KERATOPLASTY
SPATULA**
perforated



G-32727 *BINKHORST*
SYNECHIAE SPATULA
10 mm long, semi-sharp
extra delicate
overall length 129 mm



G-15477 *CASTROVIEJO*
SYNECHIAE SPATULA
7 mm long, semi-sharp
0.5 mm wide
overall length 86 mm



G-15475 *CASTROVIEJO*
CYCLODIALYSIS SPATULA
double ended, blunt
10 and 15 mm long
overall length 134 mm



G-15470 *ELSCHMIG*
CYCLODIALYSIS SPATULA
10 mm long, blunt
1.2 mm wide
overall length 127 mm



G-15480 *CASTROVIEJO*
CYCLODIALYSIS SPATULA
10 mm long, blunt
0.7 mm wide
overall length 129 mm



G-15485 *CASTROVIEJO*
CYCLODIALYSIS SPATULA
15 mm long, blunt
0.7 mm wide
overall length 129 mm

G-15400

WECKER
IRIS SPATULA

slim
1.5 mm wide, lightly curved
overall length 129 mm



G-15405

WECKER
IRIS SPATULA

wide
2.5 mm wide, lightly curved
overall length 132 mm



G-31990

WECKER
IRIS SPATULA

conical
0.9 mm wide, lightly curved
overall length 134 mm



G-15390

FRANKFURT MODEL
IRIS SPATULA

0.9 mm wide, curved
overall length 125 mm



G-15391

FRANKFURT MODEL
IRIS SPATULA

extra delicate
0.25 mm wide, curved
overall length 125 mm



G-32729

IRIS SPATULA

extra delicate, conical
7 mm long spatula, angled
tapers from 0.5 mm to 0.3 mm
overall length 114 mm



G-31975

BANGERTER
IRIS SPATULA

round handle
8 mm long spatula, angled
overall length 118 mm

G-31980

1.0 mm wide

G-31985

1.5 mm wide

G-31985

2.0 mm wide



G-15360

BANGERTER
IRIS SPATULA

flat handle
8 mm long spatula, angled
overall length 125 mm

G-15365

1.0 mm wide

G-15370

1.5 mm wide

G-15370

2.0 mm wide



G-15755

ESSEN MODEL
SPATULA

10 mm wide
25 mm angled, flat
overall length 149 mm



IRIS SPATULAS

12



G-15757 *GIESSEN MODEL*
SPATULA AND RETRACTOR
9 mm wide
angled, concave
overall length 162 mm



G-15780 *WELLS*
ENUCLEATION SPOON
overall length 147 mm



G-33912 *ZIRM*
LASIK CORNEAL PROTECTOR
7.0 x 2.5 mm corneal shield
overall length 120 mm



G-33930 *THOMAS NEUHANN*
LASIK SPATULA
with beveled blunt tip
rounded anterior and
flat posterior surface
for lifting the corneal flap
overall length 106 mm



G-33935

RAU

LASEK SPATULA

5.5 mm long spatula
for repositing and smoothing
the epithelial flap after laser ablation
overall length 116 mm



G-38607

DESCEMET INCISION HOOK

0.2 mm diameter blunt tip
for marking the area of Descemetorhexis
in recipient's eye
overall length 103 mm



G-38608

DESCEMET SCRAPER

1 mm semi-circular tip
for scraping the recipient Descemet's
membrane
overall length 103 mm



G-38622

SZURMAN

DMEK PREPARATION SPATULA

disc-shaped spatula
2.5 mm diameter, blunt
for removal of Descemet's membrane from graft
overall length 121 mm



G-38604

THOMAS NEUHANN

ENDOTHELIAL INSERTION SPATULA

with teflon insert, angled 145°, 4 x 2 mm
for easy insertion of donor lamellar button
with notched tip for "pull-through" technique
overall length 104 mm
(used with G-38606)



LASIK SPATULA · DMEK HOOKS · DSAEK GLIDE

12

G-33966

DICK

FEMTOCATARACT SPATULA

double ended with round semi-sharp tips
for easy opening of femto incisions
spatula 2.5 mm flattened, 0.65 mm wide
for main and sideport incisions
knife 90° angled, 0.9 mm wide
for arcuate incisions
overall length 100 mm



G-33967

BREYER

FEMTOCATARACT SPATULA

angled
1 mm blunt round tip
for opening femto incisions
overall length 100 mm



G-33968

HOFFMANN

**FEMTOCATARACT NUCLEUS ROTATOR
AND CHOPPER**

horizontal Y-shaped rotator, 0.75 mm wide
and 1 mm "Quick Chop" tip
overall length 120 mm



G-33950

CHANSUE

FEMTO DOUBLE INSTRUMENT

blunt spoon-shaped lenticule spatula
1.25 mm wide, vaulted and
hook, 2 mm long, angled
overall length 115 mm
to open the incision, delineate the edge
of the lenticules and separate the interfaces
during SMILE procedures



G-33952

CHANSUE

FEMTO DOUBLE INSTRUMENT

conical lenticule spatula, 9 mm long, vaulted hook, 2 mm long, angled overall length 115 mm
to open the incision, delineate the edge of the lenticules and separate the interfaces during SMILE procedures



G-33954

GUELL

FEMTO DOUBLE INSTRUMENT

1.25 mm wide spoon-shaped spatula, straight 2 mm long hook, angled overall length 113 mm
to open the incision, delineate the edge of the lenticules and separate the interfaces during SMILE procedures



G-33940

BLUM

FEMTO-LASIK ROUND SPOON

spoon-shaped spatula, 1.25 mm wide semi-sharp, bevel up, vaulted overall length 105 mm
to undermine, lift and reposit LASIK flaps created with a femtosecond laser



G-33942

BREYER

FEMTO-LASIK DOUBLE-ENDED INSTRUMENT

combination of *BLUM* spoon-shaped spatula, semi-sharp and hook with 1 mm inner edge (one blunt and one slightly sharp edge) overall length 115 mm



G-33427

PFAEFFL

FEMTO FLAP LIFTER

double ended, both ends blunt
10.5 mm conical v-shaped hook, curved and
1.5 mm modified *SINSKEY* hook
overall length 115 mm
for finding the flap edge, lifting, and retreating it



G-33943

PFAEFFL

FEMTO FLAP LIFTER

double ended
10.5 mm conical v-shaped hook, straight and
1.5 mm modified *SINSKEY* hook
overall length 115 mm
for finding the flap edge, lifting and retreating it



G-33958

PFAEFFL-BREYER

FEMTO FLAP LIFTER

double ended
10.5 mm conical v-shaped hook, curved
with double bevel tip and
1.5 mm modified *SINSKEY* hook
overall length 115 mm
for finding the flap edge, lifting and retreating it



G-33959

BREYER

FEMTO-LASIK HOOK INSTRUMENT

angled
1.3 mm wide scraper hook
to delineate and remove the lenticule
overall length 105 mm



G-33944

KOHNEN

FEMTO-LASIK DOUBLE-ENDED INSTRUMENT

11 mm long x 0.5 mm wide spatula and
2 mm modified *SINSKEY* hook, blunt tip
overall length 120 mm



G-37450

BONN MODEL

SUTURE TOOL

for scleral sutures



G-19137

CUEPPERS

STRABISMUS MUSCLE TUCKER

15 mm scale, for muscle stretching
serrated J-shaped tendon hook to
prevent the muscle from slipping



FEMTOSECOND LASIK · STRABISMUS MUSCLE TUCKER

12

G-32726

MUENSTER MODEL

SUTURE HOOK

hook 5 mm
overall length 149 mm





G-15799 *GRAEFE*
STRABISMUS HOOK
short, 5 mm
overall length 130 mm



G-15800 *GRAEFE*
STRABISMUS HOOK
small, 8 mm
overall length 131 mm



G-15805 *GRAEFE*
STRABISMUS HOOK
medium, 10 mm
overall length 133 mm



G-15810 *GRAEFE*
STRABISMUS HOOK
large, 12 mm
overall length 137 mm



G-32915 *HAMBURG MODEL*
STRABISMUS HOOK
10 mm long
slim 1 mm diameter hook
overall length 135 mm



G-15830 *MALBRAN*
STRABISMUS HOOK
9.5 mm serrated hook with right-angle knob
to prevent muscle slippage
overall length 140 mm



G-15820 *BONN MODEL*
STRABISMUS HOOK
11 mm
overall length 143 mm



G-15821 *BONN MODEL*
STRABISMUS HOOK
11 mm retinal detachment hook
with 1.0 mm hole
overall length 143 mm



G-32905 *BONN MODEL*
STRABISMUS HOOK
curved, tenotomy hook
overall length 145 mm



G-32920 *JAMESON*
STRABISMUS HOOK
11 mm, with bulbous tip
overall length 125 mm

G-37435

HATTENBACH

HORSESHOE-HOOK

to pull the trocars off the lance
and to remove the trocars from the sclera
overall length 98 mm



G-37551

BARTZ-SCHMIDT

ILM-SCRAPER

20 gauge / 0.9 mm
diamond dusted tip

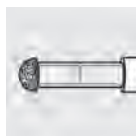

MEMBRANE SPATULAS



angled at 1.5 mm
G-37530 20 gauge / 0.9 mm



angled at 2 mm and 4 mm
G-37535 20 gauge / 0.9 mm



subretinal pick, angled at 4 mm
G-37545 20 gauge / 0.9 mm



LUCKE
curved
G-37515 20 gauge / 0.9 mm

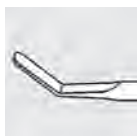

2.5 mm angled
G-37525 20 gauge / 0.9 mm



angled at 1 mm, long rakes
G-37570 20 gauge / 0.9 mm

MEMBRANE PEELERS



1.0 mm angled
G-37500 20 gauge / 0.9 mm
G-37503 23 gauge / 0.6 mm



MORRIS-KROLL
1.5 angled
G-37505 20 gauge / 0.9 mm



0.65 mm angled
black chromium
G-37506 20 gauge / 0.9 mm



0.4 mm, recessed, angled
black chromium
G-37511 20 gauge / 0.9 mm
G-37512 23 gauge / 0.6 mm
G-37513 25 gauge / 0.5 mm

SCLERAL DEPRESSORS LOCALIZERS





G-32152 *LAQUA*
SCLERAL DEPRESSOR
with pocket clip
3 x 1.8 mm teardrop-shaped tip
overall length 128 mm



G-32150 *LAQUA*
SCLERAL DEPRESSOR
double-ended with pocket clip
3 x 1.8 mm teardrop-shaped tip
2 mm diameter scleral marker
overall length 134 mm



G-32153 *LUCKE*
SCLERAL DEPRESSOR
with pocket clip
3.8 x 2.0 mm teardrop-shaped tip
overall length 128 mm



G-32027 *KREISSIG*
SCLERAL DEPRESSOR
double-ended with pocket clip
conical tip with 2.4 mm diameter
and 6.0 mm bar
overall length 128 mm

G-15710

MEYER-SCHWICKERATH
LOCALIZER AND SCLERAL DEPRESSOR
 for fixation and rotation



G-32715

SCHOCKET
SCLERAL DEPRESSOR
 double-ended with pocket clip
 3 x 2 mm teardrop tip and
 6.0 mm bar
 overall length 132 mm



G-32714

SCLERAL DEPRESSOR
 double-ended
 2 mm and 4 mm diameter
 diamond dusted tips
 overall length 120 mm

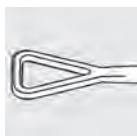

G-37445

HATTENBACH
TRIANGLE SCLERAL DEPRESSOR
 for gentle buckling and firm grip without the risk of rupture
 overall length 133 mm



PROBES DILATORS



G-150301 *WILDER*
LACRIMAL PROBE
delicate, long taper
0.45 mm tip diameter
overall length 104 mm



G-150302 *WILDER*
LACRIMAL PROBE
medium, medium taper
0.50 mm tip diameter
overall length 104 mm



G-150303 *WILDER*
LACRIMAL PROBE
strong, short taper
0.55 mm tip diameter
overall length 104 mm



G-150401 *WILDER*
LACRIMAL PROBE
slim
delicate, long taper
0.30 mm tip diameter
overall length 95 mm



G-150402 *WILDER*
LACRIMAL PROBE
slim
medium, medium taper
0.35 mm tip diameter
overall length 95 mm



G-150403 *WILDER*
LACRIMAL PROBE
slim
strong, short taper
0.40 mm tip diameter
overall length 95 mm



G-15020 *GIESSEN MODEL*
LACRIMAL PROBE
11 mm tapered shaft, angled
0.4 mm tip width
overall length 77 mm



KELLNAR
RETROGRADE PROBE
 for canalicular repair
 0.5 mm suture hole
 overall length 95 mm
 right
 left



G-15050
G-15055



G-15095
PIGTAIL PROBE
 double-ended
 for canalicular repair
 with 0.4 mm suture holes
 overall length 140 mm



G-15096
PIGTAIL PROBE
 double-ended
 for canalicular repair
 with 1.0 mm suture hooks
 overall length 140 mm



PROBE FOR STROMAL CHANNEL
 for corneal implants in patients with
 keratoconus
 overall length 115 mm
 bent to the left
 bent to the right



G-37602
G-37604



BOWMAN
LACRIMAL PROBE
cylindrical, silver
overall length 130 mm

- G-150001 size 0000/000
- G-150002 size 00/0
- G-150003 size 1/2
- G-150004 size 3/4
- G-150005 size 5/6



BOWMAN
LACRIMAL PROBE
cylindrical, stainless steel
overall length 130 mm

- G-150101 size 0000/000
- G-150102 size 00/0
- G-150103 size 1/2
- G-150104 size 3/4
- G-150105 size 5/6



BOWMAN
LACRIMAL PROBE
bulbous tips, silver
overall length 130 mm

- G-150051 size 0000/000
- G-150052 size 00/0
- G-150053 size 1/2
- G-150054 size 3/4
- G-150055 size 5/6



BOWMAN
LACRIMAL PROBE
bulbous tips, stainless steel
overall length 130 mm

- G-150151 size 0000/000
- G-150152 size 00/0
- G-150153 size 1/2
- G-150154 size 3/4
- G-150155 size 5/6

JUENEMANN

LACRIMAL PROBE

with 72 mm probe and 18 mm grip plate to insert suture material to insert suture material provided with cleaning adaptor G-31022

- G-33193 0.6 mm diameter
- G-33194 0.8 mm diameter
- G-33195 1.0 mm diameter

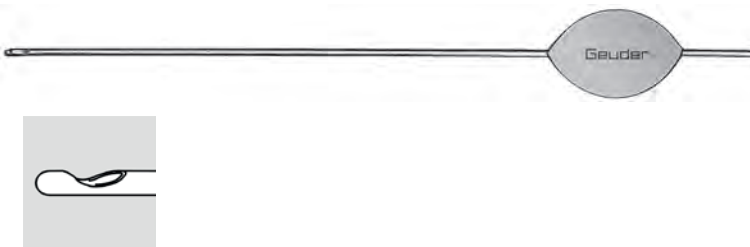

G-15315

KRUMEICH

DALK PROBE

for deep lamellar keratoplasty
12 mm tapered probe
overall length 73 mm



- G-15105 right
- G-15110 left

MACKENSEN

TRABECULAR PROBE

7 mm curved probe
overall length 92 mm



- G-15125 right
- G-15130 left

HARMS

TRABECULAR PROBE

dual 9.5 mm curved probes
3 mm spread
overall length 46 mm



THOMAS NEUHANN

U-SHAPED PROBE

with holding plate
dual 9 mm curved probes
3 mm spread
overall length 12 mm

- G-15136 0.30 mm probe diameter
- G-15138 0.25 mm probe diameter



G-15137

THOMAS NEUHANN

HOLDER

with lock
for U-shaped probes G-15136 and G-15138
overall length 92 mm



TRABECULAR PROBES · U-SHAPED PROBE · LACRIMAL PROBES

CANNULAS I/A INSTRUMENTS



LACRIMAL	189
ANTERIOR CHAMBER MAINTAINERS	191
HYDRODISSECTION	192
IRRIGATION VECTIS	193
VISCOELASTIC	194
CAPSULE POLISHERS	195
LASIK	196
BIMANUAL IRRIGATION/ASPIRATION	198
COAXIAL IRRIGATION/ASPIRATION	203
BACKFLUSH	206
INFUSION	209

LACRIMAL CANNULA
conical, straight
tapers from 19 to 25 gauge
25 mm shaft

G-33140 silver
G-33135 stainless steel



LACRIMAL CANNULA
conical, strongly curved
tapers from 19 to 25 gauge
25 mm shaft

G-15140 silver
G-15141 stainless steel



LACRIMAL CANNULA
conical, angled at 10 mm
tapers from 19 to 25 gauge
25 mm shaft

G-15150 silver
G-15151 stainless steel



LACRIMAL CANNULA
conical, angled at 18 mm
tapers from 19 to 25 gauge
25 mm shaft

G-15160 silver
G-15161 stainless steel



G-15190 *ANEL*
LACRIMAL CANNULA
straight
15 mm shaft
23 gauge / 0.64 mm



G-15195 *ANEL*
LACRIMAL CANNULA
strongly curved
16 mm shaft
23 gauge / 0.64 mm



- LACRIMAL CANNULA**
 cylindrical, straight
G-33160 20 gauge / 0.9 x 35 mm
G-33170 no. 12, 0.72 x 32 mm
G-33175 no. 14, 0.67 x 30 mm
G-33180 no. 16, 0.60 x 22 mm
G-33185 no. 18, 0.45 x 22 mm
G-33190 no. 20, 0.42 x 22 mm



- G-15170** *BONN MODEL*
LACRIMAL CANNULA
 with probe tip
 1.15 mm diameter olive tip



- BANGERTER*
LACRIMAL PROBE CANNULA
 straight, 0.6 mm side port
G-15271 23 gauge / 0.64 x 60 mm
G-15272 21 gauge / 0.80 x 40 mm
G-15273 23 gauge / 0.64 x 40 mm



- G-33197** *JUENEMANN*
LACRIMAL PROBE CANNULA
 to insert suture material
 21 gauge / 0.8 x 35 mm

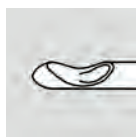

- G-33198** *JUENEMANN*
LACRIMAL PROBE CANNULA
 with grip plate
 65 mm probe
 to insert suture material
 21 gauge / 0.8 x 65 mm

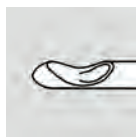

G-15375 **RETROBULBAR INJECTION CANNULA**
G-32605 24 gauge / 0.6 x 60 mm
G-32600 24 gauge / 0.6 x 35 mm
G-15376 25 gauge / 0.5 x 35 mm
G-15377 25 gauge / 0.5 x 50 mm
G-15377 25 gauge / 0.5 x 40 mm



G-15200 *CRANZ*
EYE DOUCHE
 irrigation through five front ports
 silver



G-33416 *BOPP*
ANTERIOR CHAMBER INFUSION CANNULA
 anterior chamber maintainer with
 threaded tip for better fixation
 and silicone tube
 20 gauge / 0.9 mm



G-33422 *BONN MODEL*
ANTERIOR CHAMBER INFUSION CANNULA
 self-retaining textured tip
 dual 0.35 mm side ports
 silicone tube 15 cm
 23 gauge / 0.6 mm



G-16105 **IRRIGATION CYSTOTOME CANNULA**
 26 gauge / 0.45 mm

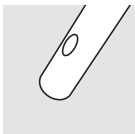

G-15220 **ENZYME CANNULA**
 24 gauge / 0.6 mm

G-15275 CYCLODIALYSIS SPATULA CANNULA

12 mm long spatula
anterior 0.2 mm port
26 gauge / 0.45 mm



G-31355 BUSSE CYCLODIALYSIS SPATULA CANNULA

12 mm long spatula
dual 0.2 mm port
26 gauge / 0.45 mm



G-15250 G-32166 G-32167 SAUTTER HYDRODISSECTION CANNULA

front opening
flattened tip
vertical, 27 gauge / 0.4 mm
vertical, 26 gauge / 0.45 mm
horizontal, 27 gauge / 0.4 mm



vertical
G-15250
G-32166

horizontal
G-32167



G-32155 TUEBINGEN MODEL HYDRODISSECTION CANNULA

30 gauge / 0.3 mm

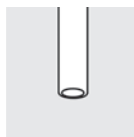

G-15185 FRANKFURT MODEL HYDRODISSECTION CANNULA

27 gauge / 0.4 mm

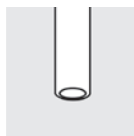

G-31895 HYDRODISSECTION CANNULA

vertically flattened tip
front opening
24 gauge / 0.6 x 20 mm



G-15252 G-15253 SPIRIG HYDRODISSECTION CANNULA

for manual lens fragmentation
right
left



HYDRODISSECTION · CYCLODIALYSIS

15

G-16115 IRRIGATION VECTIS CANNULA

4 front ports
5 mm wide lens loop
curved

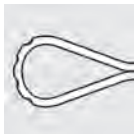

G-32759 IRRIGATION VECTIS CANNULA

small model
4 front ports
4 mm wide lens loop
curved

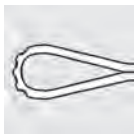

G-31510 KLÖCKNER EXPRESSOR CANNULA

8 mm wide lens loop
4 front ports
lightly curved



G-31807 HEALON - VISCOELASTIC CANNULA

flattened tip, angled at 6 mm
30 mm shaft
21 gauge / 0.8 mm



G-22619 PH. JACOBI TRABECULAR ASPIRATION CANNULA

angled at 13 mm
24 gauge / 0.6 mm



G-15188 G-15189 BURK IRRIGATION TRABECULOTOMY CANNULA

8 mm curved irrigation probe
30 gauge / 0.3 mm
angled right
angled left



G-33199 NAGATA SUB-TENON INJECTION CANNULA

for atraumatic penetration and
injection of anesthetic agent
24 gauge / 0.6 mm



G-15180 **IRRIGATION CANNULA**
 bulbous tip, 0.75 mm diameter tip
 extra delicate
 26 gauge / 0.45 mm



G-15230
G-15240 *BONN MODEL*
IRRIGATION CANNULA
 flattened tip, front opening
 delicate, 0.5 x 1.5 mm
 medium, 0.6 x 1.9 mm



G-16134
G-16135
G-16136 *BINKHORST*
IRRIGATION CANNULA
 U-shaped
 22 gauge / 0.7 mm
 straight
 angled right
 angled left



G-32760
G-32765 *MUELLER*
IRRIGATION CANNULA
 J-shaped with probe tip
 26 gauge / 0.45 x 19 mm
 angled left
 angled right



G-16138 *RENTSCH*
IRRIGATION CANNULA
 J-shaped
 angled at 10 mm
 26 gauge / 0.45 x 24 mm



G-16106 *SIMCOE*
IRRIGATION / ASPIRATION CANNULA
 dual shaft
 0.3 mm diameter aspiration port
 front opening irrigation port
 23 gauge / 0.64 mm
 with silicone tube and Luer-Lock hub

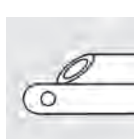

G-16120 **IRRIGATION / ASPIRATION CANNULA
COAXIAL**

straight
aspiration port 0.4 mm
infusion tube 18 gauge / 1.2 mm

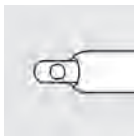

G-15225 **ASPIRATION CANNULA**
lightly curved, front opening
G-15226 delicate, 19 gauge / 1.1 mm
standard, 17 gauge / 1.5 mm



G-16125 *KRATZ*
CAPSULE POLISHING CANNULA
angled at 2 mm
half-textured tip
23 gauge / 0.64 mm



G-16133 *TEPING*
ASPIRATION POLISHING CANNULA
0.3 mm posterior port
half-textured tip, curved
23 gauge / 0.64 mm



G-16130 **CAPSULE POLISHING CANNULA**
with half-textured ball tip
18 gauge / 1.2 mm



G-16132 *PAPST*
CAPSULE POLISHING CANNULA
0.75 mm hemisphere textured tip
25 gauge / 0.5 mm



G-32529 *KYU*
CAPSULE POLISHING CANNULA
2 mm disc-shaped tip
textured
G-32527 22 gauge / 0.7 mm
23 gauge / 0.64 mm



G-32528

GREITE
CAPSULE POLISHING CANNULA
 curette tip
 textured
 22 gauge / 0.7 mm



G-32774

BRAUWEILER
ASPIRATION CANNULA
 angled at 13 mm
 textured polisher tip
 0.3 mm beveled port
 21 gauge / 0.8 mm

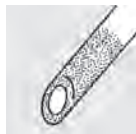

G-32769

H.-R. KOCH
ASPIRATION CANNULA
 angled at 14 mm
 0.3 mm anterior port
 half-textured, spatulated tip
 21 gauge / 0.8 mm



G-32776

BRAUWEILER
IRRIGATION CANNULA
 angled at 12 mm
 front opening
 21 gauge / 0.8 mm



G-32772

BRAUWEILER
IRRIGATION CANNULA
 angled at 13 mm
 textured 0.8 mm iris retractor and
 capsule polisher
 21 gauge / 0.8 mm



G-33909

W. BAUER
LASIK CANNULA
 double-armed
 6 ports
 for irrigation of the flap and stromal bed
 25 gauge / 0.5 mm



CAPSULER POLISHERS · LASIK

15

G-33910 *ZIRM*
LASIK DISSECTOR CANNULA
flattened
front opening
25 gauge / 0.5 mm



G-33911 *ZIRM*
LASIK IRRIGATION CANNULA
flattened and textured tip
with 5 irrigation ports
20 gauge / 0.9 mm



G-15310 *KRUMEICH*
CORNEAL IRRIGATION CANNULA
for big bubble technique during DALK
semi-sharp dissector tip
0.2 mm posterior port
27 gauge / 0.4 mm



KRUMEICH
CORNEAL IRRIGATION CANNULA
for big bubble technique during DALK
angled at 12 mm
23 gauge / 0.6 mm
G-15312 0.4 mm anterior port
G-15314 0.4 mm posterior port



G-22550 **IRRIGATION CANNULA HANDPIECE**
overall length 115 mm



G-32015 **IRRIGATION CANNULA HANDPIECE**
male / female connectors
overall length 112 mm

G-32771 *BRAUWEILER*
IRRIGATION CANNULA HANDPIECE
 male / female connectors
 78 mm



G-32773 *BRAUWEILER*
ASPIRATION CANNULA HANDPIECE
 male / male connectors
 80 mm



G-32778 *KEERL*
IRRIGATION CANNULA HANDPIECE
 with silicone tube



G-32010 **IRRIGATION CANNULA HANDPIECE**
 with silicone tube



SCHMACK
 21 gauge / 0.8 mm



G-22632 **IRRIGATION HANDPIECE**
 0.5 mm port

G-22633 **ASPIRATION HANDPIECE**
 0.3 mm port

D.D. KOCH - T. KOHNEN
ASPIRATION HANDPIECE

0.3 mm aspiration port
 textured tip



G-22100 22 gauge / 0.7 mm
G-22102 23 gauge / 0.6 mm



G-22101

D.D. KOCH - T. KOHNEN
IRRIGATION HANDPIECE
front opening
22 gauge / 0.7 mm



G-22105
G-22106

ASPIRATION HANDPIECE
0.25 mm aspiration port
conical tip
oval tube 0.95 x 0.55 mm
smooth
textured



G-22107

IRRIGATION HANDPIECE
0.5 mm irrigation port
conical tip
oval tube 0.95 x 0.55 mm

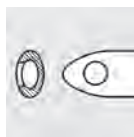

G-22637

SCHMACK
ASPIRATION HANDPIECE
4 x 0.15 mm posterior ports
textured tip
23 gauge / 0.6 mm



G-32011 ASPIRATION HANDPIECE

0.3 mm aspiration port
textured, conical tip
21 gauge / 0.8 mm



G-32012 IRRIGATION HANDPIECE

dual 0.5 mm irrigation ports
textured, conical tip
21 gauge / 0.8 mm



G-32018 BRAUWEILER ASPIRATION HANDPIECE

angled at 13 mm
0.3 mm beveled port
textured tip
21 gauge / 0.8 mm



G-32019 H.-R. KOCH ASPIRATION HANDPIECE

angled at 14 mm
0.3 mm anterior port
half-textured, spatulated tip
21 gauge / 0.8 mm



G-32016 *BRAUWEILER*
IRRIGATION HANDPIECE
angled at 12 mm
front opening
21 gauge / 0.8 mm



G-32017 *BRAUWEILER*
IRRIGATION HANDPIECE
angled at 13 mm
textured 0.8 mm iris retractor and
capsule polisher
21 gauge / 0.8 mm



G-32026 *R. KOCH*
ASPIRATION HANDPIECE
0.3 mm aspiration port
textured tip
19 gauge / 1.1 mm



G-32028 *R. KOCH*
IRRIGATION HANDPIECE
angled
dual 0.75 mm side ports
19 gauge / 1.1 mm



G-32014

R. KOCH

IRRIGATION CHOPPER

angled
dual 0.75 mm side ports
1 mm angled chopper tip
19 gauge / 1.1 mm



G-32059

DICK

IRRIGATION CHOPPER

angled
dual 0.75 mm side ports
1 mm curved chopper tip
19 gauge / 1.1 mm



G-38601

ALTHAUS / CARTSBURG

IRRIGATION DESCMET HOOK

hook diameter: 0.25 mm
hook length: 0.6 mm
for Descemetorhexis
rhombic 0.9 x 0.6 mm irrigation tube
overall length 98 mm



G-38602

THOMAS NEUHANN

IRRIGATION DESCMET SCRAPER

scraper width: 0.8 mm
scraper length: 0.6 mm
rhombic 0.9 x 0.6 mm irrigation tube
for peripheral scraping of the recipient bed
overall length 94 mm



G-38631

SZURMAN
DMEK IRRIGATION HANDPIECE
curved, closed tip
side port 0.3 mm
tube 23 gauge / 0.6 mm



G-38632

SZURMAN
DMEK IRRIGATION HANDPIECE
curved, front opening
tube 23 gauge / 0.6 mm



G-24318
G-24418

PEP 2.2 MM I/A HANDPIECE
Pure Efficiency Phaco
for 2.2 mm incisions
0.3 mm aspiration port
coaxial I/A straight tip
coaxial I/A 30° angled tip

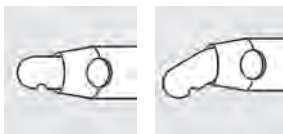

with G-24311 PEP infusion sleeve

G-24311

PEP 2.2 MM INFUSION SLEEVE
Pure Efficiency Phaco
for 2.2 mm incisions
purple translucent silicone





PEP 2.4 MM I/A HANDPIECE

Pure Efficiency Phaco
for 2.4 mm incisions
0.3 mm aspiration port
coaxial I/A straight tip
coaxial I/A 30° angled tip



G-24332
G-24432

with G-24314 PEP infusion sleeve

G-24314

PEP 2.4 MM INFUSION SLEEVE

Pure Efficiency Phaco
for 2.4 mm incisions
green translucent silicone

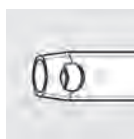

G-24330

I/A HANDPIECE

coaxial straight tip
0.3 mm aspiration port
with G-24100 infusion sleeve

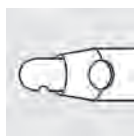

G-24430
G-24435
G-24440

I/A HANDPIECE

coaxial 30° angled tip
0.3 mm aspiration port
0.35 mm aspiration port
0.4 mm aspiration port



with G-24100 infusion sleeve

COAXIAL IRRIGATION/ASPIRATION

G-24100 **INFUSION SLEEVE**
blue silicone
for I/A handpieces



PAPST
I/A HANDPIECE

coaxial
infusion tube 16 gauge / 1.6 mm
aspiration port 0.3 mm, straight
G-22525
G-22527 aspiration port 0.4 mm, straight
G-22540 aspiration port 0.3 mm, angled 30°
G-22542 aspiration port 0.4 mm, angled 30°
G-22545 aspiration port 0.5 mm, angled 30°

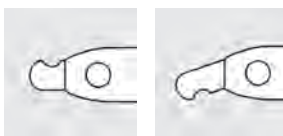

G-22615 *PAPST*
I/A HANDPIECE
coaxial 30° angled tip
aspiration port 0.3 mm
infusion tube 18 gauge / 1.3 mm



G-22556 *HUNOLD*
I/A HANDPIECE
coaxial, curved
aspiration port 0.3 mm
infusion tube 18 gauge / 1.3 mm



G-33045 BACKFLUSH HANDPIECE

with Luer cone
overall length 110 mm



G-31805 BACKFLUSH HANDPIECE

with silicone chamber and Luer cone
overall length 110 mm



G-37002 BACKFLUSH HANDPIECE

with silicone chamber and Luer-Lock connector
overall length 115 mm



G-37000 BACKFLUSH HANDPIECE

with silicone chamber and chuck
overall length 110 mm



for backflush tips G-37010 up to G-37080

SILICONE CHAMBER

for backflush handpieces
G-31805, G-37000, G-37002

G-31806

reusable

G-34806

single use, 10 pcs. per box, sterile



G-37005 BACKFLUSH HANDPIECE

with large silicone chamber
rotatable chuck



for backflush cannulas G-37010 up to G-37080

G-37006 SILICONE CHAMBER

large, for backflush handpiece G-37005







RETINAL · BACKFLUSH HANDPIECES

<p>G-33050 G-33054 G-33053</p>	<p>BACKFLUSH CANNULA 35 mm shaft 20 gauge / 0.9 mm</p>		
	<p>23 gauge / 0.6 mm</p>		
	<p>25 gauge / 0.5 mm</p>		

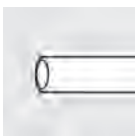
<p>G-33070</p>	<p>BACKFLUSH CANNULA 35 mm shaft 20 gauge / 0.9 mm shaft 25 gauge / 0.5 mm tip 3.5 mm tapered tip</p>		
-----------------------	--	---	---

<p>G-33071</p>	<p>BACKFLUSH CANNULA 35 mm shaft 0.5 mm side port 20 gauge / 0.9 mm</p>		
-----------------------	--	---	---

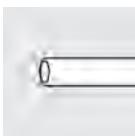
<p>G-33072</p>	<p><i>LAQUA</i> BACKFLUSH CANNULA 35 mm shaft inside diameter: 21 gauge / 0.8 mm outside diameter: 19 gauge / 1.1 mm</p>		
-----------------------	---	---	---

<p>G-33073</p>	<p><i>KAMPIK</i> BACKFLUSH CANNULA 35 mm shaft inside diameter: 22 gauge / 0.7 mm outside diameter: 20 gauge / 0.9 mm</p>		
-----------------------	--	---	---

<p>G-33075</p>	<p>BACKFLUSH CANNULA 35 mm shaft 0.8 mm silicone brush 20 gauge / 0.9 mm</p>		
-----------------------	---	---	---

<p>G-33077</p>	<p>BACKFLUSH CANNULA 20 gauge / 0.9 mm shaft 24 gauge / 0.55 mm tip 7 mm tapered tip, angled at 3.5 mm</p>		
-----------------------	---	---	---

G-37010 **BACKFLUSH TIP**
 35 mm shaft
 20 gauge / 0.9 mm

G-37011
 23 gauge / 0.6 mm

G-37012
 25 gauge / 0.5 mm



G-37015 **BACKFLUSH TIP**
 35 mm shaft
 angled at 3 mm
 20 gauge / 0.9 mm



G-37020 **BACKFLUSH TIP**
 35 mm shaft
 0.8 mm silicone brush
 20 gauge / 0.9 mm



G-37025 **BACKFLUSH TIP**
 35 mm shaft
 angled at 6 mm
 0.8 mm silicone brush
 20 gauge / 0.9 mm



G-37035 **BACKFLUSH TIP**
 35 mm shaft
 0.8 mm silicone tip
 20 gauge / 0.9 mm



G-37046 *KLEIN*
BACKFLUSH TIP
 20 gauge / 0.9 mm shaft
 26 gauge / 0.45 mm tip
 2 mm tapered tip
 overall length 35 mm



G-37065 **BACKFLUSH TIP**
 35 mm shaft
 20 gauge / 0.9 mm shaft
 30 gauge / 0.3 mm tip
 tapered tip, angled at 5 mm
 oval aspiration port



RETINAL · BACKFLUSH TIPS

15

G-37080

BACKFLUSH TIP

35 mm shaft
20 gauge / 0.9 mm shaft
23 gauge / 0.6 mm tip
2 mm tapered tip
overall length 35 mm



G-33420

INFUSION CANNULA

silicone tube 40 cm
Luer-Lock metal adapter
20 gauge / 0.9 mm
beveled, 4.0 mm (single-use G-33463)
G-33425 beveled, 5.0 mm
G-33430 beveled, 6.0 mm



G-33450

INFUSION CANNULA

silicone tube 40 cm
Luer-Lock plastic adapter
20 gauge / 0.9 mm
beveled, 4.0 mm
G-33451 beveled, 5.0 mm
G-33452 beveled, 6.0 mm



G-33484

INJECTION CANNULA

for viscous fluids, without silicone tube
for butterfly-19 cannula
20 gauge / 0.9 mm
beveled, 4.0 mm
G-33485 beveled, 5.0 mm
G-33486 beveled, 6.0 mm



G-33494

INJECTION CANNULA

for viscous fluids, without silicone tube
for butterfly-21 cannula
20 gauge / 0.9 mm
beveled, 4.0 mm
G-33495 beveled, 5.0 mm
G-33496 beveled, 6.0 mm



G-32180

DUISBURG MODEL
INJECTION CANNULA

for viscous fluids
25 cm silicone tube with 2 metal sleeves
and Luer-Lock adapter
20 gauge / 0.9 mm
beveled, 4.0 mm
G-32181 beveled, 5.0 mm
G-32182 beveled, 6.0 mm

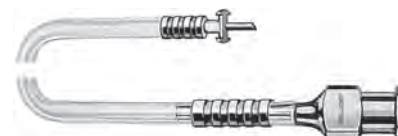

HAMBURG MODEL

INJECTION CANNULA

for viscous fluids
25 cm silicone tube with metal sleeve
and Luer-Lock adapter
3 spare silicone tubes

- G-33470** 20 gauge / 0.9 mm, beveled, 4 mm
- G-33471** 20 gauge / 0.9 mm, beveled, 5 mm
- G-33472** 20 gauge / 0.9 mm, beveled, 6 mm
- G-33473** 23 gauge / 0.6 mm, beveled, 4 mm
- G-33474** 23 gauge / 0.6 mm, beveled, 6 mm



G-33475 SPARE SILICONE TUBE

for injection cannulas
25 cm
3 pcs. per box



WEBER

ASPIRATION CANNULA

for viscous fluids
inside diameter: 22 gauge / 0.7 mm
outside diameter: 20 gauge / 0.9 mm

- G-33051** 5 mm shaft
- G-33052** 10 mm shaft

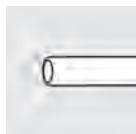

G-37390 ASPIRATION CANNULA

23 gauge / 0.6 mm
10 mm shaft



G-33056 ROIDER ASPIRATION CANNULA

for viscous fluids
0.7 mm side port
19 gauge / 1.0 mm



G-33055 PFCL CANNULA

with dual shaft
24 gauge / 0.55 mm
25 gauge / 0.5 mm, lateral tube

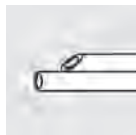

G-33057 CHANG PFCL CANNULA

for injection of heavy fluids
dual bore, coaxial
25 gauge / 0.5 mm tip
20 gauge / 0.9 mm shaft

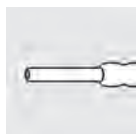

HEIDELBERG MODEL

CANNULA

for injection or aspiration of viscous fluids
and Densiron[®] 68, bevel 30°

G-32699

19 gauge / 1.1 mm

G-32698

18 gauge / 1.2 mm

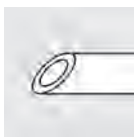

STOPPER

for viscous fluid aspiration
with tube connection for single-use syringe

G-33065

10 ml syringe

G-33066

20 ml syringe



PRESSURE TUBE

for injection of viscous fluids
Luer-Lock female / male
reusable

G-32697

reusable

G-32696

single use, 10 pcs. per box, sterile

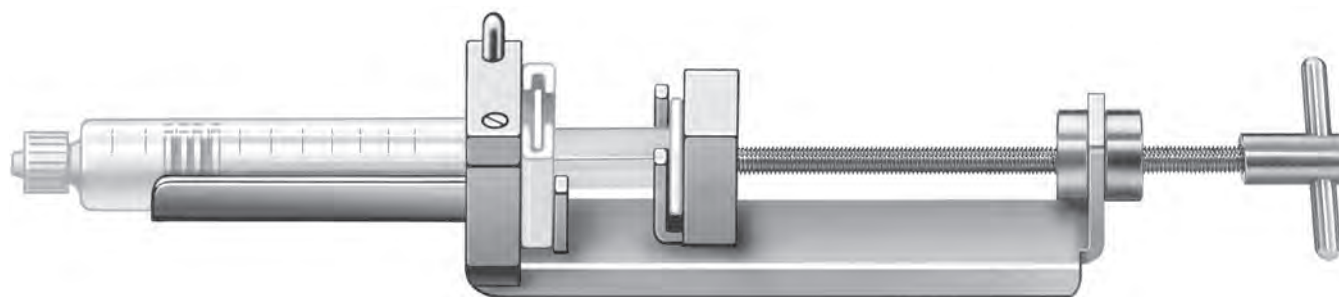

G-28752

SYRINGE HOLDER

for manual injection of
viscous fluids in glass syringes,
with clamp and retraction mechanism

SYRINGE CLIP

customized labeling
for 2 ml syringes
for 5 ml syringes

G-19960

G-19961



SILICONE BULB

with Luer Cone
20 ml
60 ml

G-32665

G-32670



SINGLE USE INSTRUMENTS



NANOEDGE TREPHINES AND PUNCHES	215
NANOEDGE SURGICAL KNIVES	217
UNO COLORLINE (SCISSORS · FORCEPS · PROBES · TROCARS · FIBER OPTICS · VITREOUS CUTTERS)	218
SPECULUM	223
DMEK CARTRIDGE	223
IRIS RETRACTOR	223
LACRIMAL INTUBATION	223
CANNULAS	224
BIMANUAL HANDPIECE SET	227
BACKFLUSH	227
INFUSION / INJECTION CANNULAS	228
SCLERAL BUCKLING COMPONENTS	232

NANOEDGE TREPHINES

length 16 mm
sterile, single-use

G-520400	4.00 mm	G-520825	8.25 mm	G-521350	13.50 mm
G-520500	5.00 mm	G-520850	8.50 mm	G-521400	14.00 mm
G-520550	5.50 mm	G-520875	8.75 mm	G-521450	14.50 mm
G-520600	6.00 mm	G-520900	9.00 mm	G-521500	15.00 mm
G-520625	6.25 mm	G-520950	9.50 mm	G-521550	15.50 mm
G-520650	6.50 mm	G-521000	10.00 mm	G-521600	16.00 mm
G-520675	6.75 mm	G-521050	10.50 mm	G-521650	16.50 mm
G-520700	7.00 mm	G-521100	11.00 mm	G-521700	17.00 mm
G-520725	7.25 mm	G-521150	11.50 mm	G-521800	18.00 mm
G-520750	7.50 mm	G-521200	12.00 mm		
G-520775	7.75 mm	G-521250	12.50 mm		
G-520800	8.00 mm	G-521300	13.00 mm		



G-500001 **NANOEDGE SINGLE-USE CORNEAL CUTTING BLOCK**
Teflon, sterile



NANOEDGE TREPHINE PUNCHES

sterile, single-use

G-540600	6.00 mm	G-540725	7.25 mm	G-540850	8.50 mm
G-540625	6.25 mm	G-540750	7.50 mm	G-540875	8.75 mm
G-540650	6.50 mm	G-540775	7.75 mm	G-540900	9.00 mm
G-540675	6.75 mm	G-540800	8.00 mm	G-540925	9.25 mm
G-540700	7.00 mm	G-540825	8.25 mm	G-540950	9.50 mm



NANOEDGE VACUUM TREPHINE PUNCHES

sterile, single-use

G-560600	6.00 mm	G-560725	7.25 mm	G-560850	8.50 mm
G-560625	6.25 mm	G-560750	7.50 mm	G-560875	8.75 mm
G-560650	6.50 mm	G-560775	7.75 mm	G-560900	9.00 mm
G-560675	6.75 mm	G-560800	8.00 mm	G-560925	9.25 mm
G-560700	7.00 mm	G-560825	8.25 mm	G-560950	9.50 mm

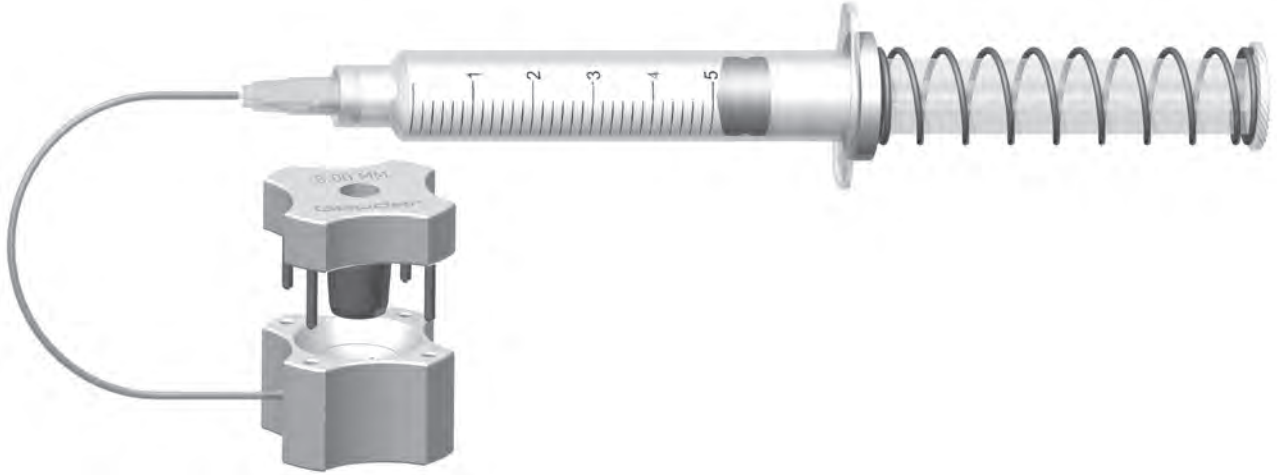

NANOEDGE VACUUM TREPHINE radial

sterile, single-use

G-570600	6.00 mm	G-570750	7.50 mm	G-570850	8.50 mm
G-570650	6.50 mm	G-570775	7.75 mm	G-570875	8.75 mm
G-570700	7.00 mm	G-570800	8.00 mm	G-570900	9.00 mm
G-570725	7.25 mm	G-570825	8.25 mm		

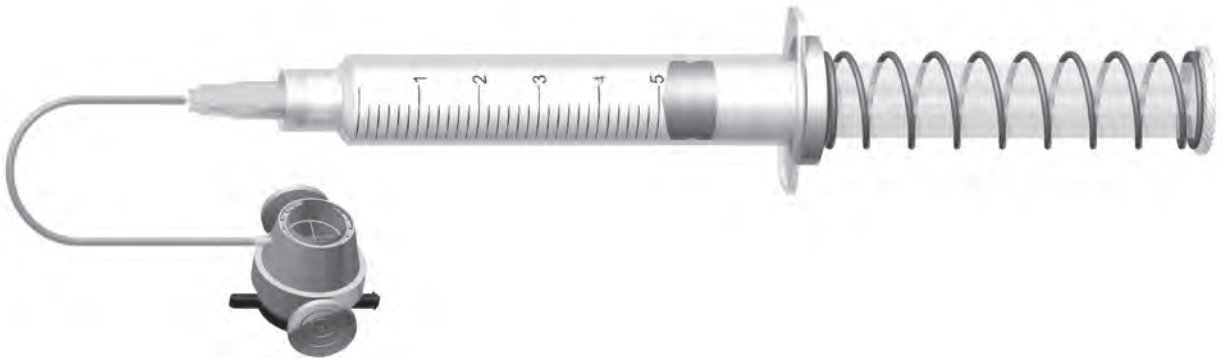

SINGLE-USE KNIVES FOR OPHTHALMIC SURGERY

6 pcs. per box
sterile



NANOEDGE PARACENTESIS KNIVES



G-34026 15°
G-34064 15° protect
with sliding guard



G-34031 22,5°



G-34036 30°



NANOEDGE MVR STILETT straight
diameter insertable instruments

G-34181 20 gauge / 0.9 mm
G-34192 23 gauge / 0.6 mm
G-34198 25 gauge / 0.5 mm

incision / blade width

1.2 mm
0.8 mm
0.7 mm



NANOEDGE MVR STILETT angled
diameter insertable instruments

G-34191 20 gauge / 0.9 mm
G-34196 23 gauge / 0.6 mm
G-34197 25 gauge / 0.5 mm

incision / blade width

1.2 mm
0.8 mm
0.7 mm



NANOEDGE PHACO SLIT KNIFE

angled, double bevel

G-34050 1.80 mm
G-34051 2.20 mm
G-34052 2.40 mm
G-34053 2.50 mm



CLEAR CORNEA KNIFE

angled, double bevel

G-34122 2.75 mm
G-34126 3.00 mm

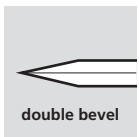

double bevel

G-34054 2.75 mm
G-34055 2.85 mm
G-34060 2.20 mm, protect, with sliding guard
G-34061 2.40 mm, protect, with sliding guard
G-34062 2.85 mm, protect, with sliding guard

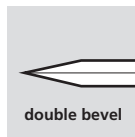

double bevel



NANOEDGE CRESCENT KNIFE

angled, bevel up

G-34081 2.0 mm

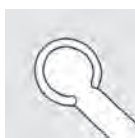

NANOEDGE SPOON KNIFE

angled, double bevel

G-34086 2.2 mm



NANOEDGE IMPLANT KNIFE

angled, bevel up

G-34146 6.0 mm

20G RED: 20 GAUGE / 0.9 MM

23G GREEN: 23 GAUGE / 0.6 MM

25G BLUE: 25 GAUGE / 0.5 MM

SCISSORS

SINGLE-USE VITREOUS SCISSORS UNO COLORLINE

straight, sterile



G-42061 20G, 1 pcs. per box

G-42361 23G, 1 pcs. per box

G-42561 25G, 1 pcs. per box

SINGLE-USE VITREOUS SCISSORS UNO COLORLINE

curved, sterile



G-42362 23G, 1 pcs. per box

G-46362 23G, 6 pcs. per box

G-42562 25G, 1 pcs. per box

G-46562 25G, 6 pcs. per box

HANDLES

HANDLE UNO COLORLINE 20G, 23G, 25G

titanium handle for UNO Colorline
single-use tips

G-40006 6 mm diameter

G-40008 8 mm diameter



FORCEPS

SINGLE-USE VITREOUS FORCEPS ENDGRIPPING UNO COLORLINE

straight, extra delicate,
endgripping 0.3 mm x 0.1 mm, sterile



G-42041 20G, 1 pcs. per box
G-46041 20G, 6 pcs. per box

G-42341 23G, 1 pcs. per box
G-46341 23G, 6 pcs. per box

G-42541 25G, 1 pcs. per box
G-46541 25G, 6 pcs. per box

HATTENBACH

SINGLE-USE VITREOUS FORCEPS WAVE DESIGN UNO COLORLINE

straight, wave design, 0.3 mm x 0.5 mm,
sterile

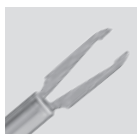

G-42042 20G, 1 pcs. per box
G-46042 20G, 6 pcs. per box

G-42342 23G, 1 pcs. per box
G-46342 23G, 6 pcs. per box

G-42542 25G, 1 pcs. per box
G-46542 25G, 6 pcs. per box

SINGLE-USE VITREOUS FORCEPS CROCODILE DESIGN UNO COLORLINE

straight, crocodile design 0.3 mm x 2.5 mm,
sterile



G-42043 20G, 1 pcs. per box

G-42343 23G, 1 pcs. per box
G-46343 23G, 6 pcs. per box

SINGLE-USE TANO FORCEPS UNO COLORLINE

straight, sterile



G-42044 20G, 1 pcs. per box

G-42344 23G, 1 pcs. per box

G-42544 25G, 1 pcs. per box

20G RED: 20 GAUGE / 0.9 MM

23G GREEN: 23 GAUGE / 0.6 MM

25G BLUE: 25 GAUGE / 0.5 MM

ENDO PROBES

SINGLE-USE ENDO-PROBE S UNO COLORLINE

straight, plug for GEUDER endoTRON, sterile



G-61201 20G, 5 pcs. per box

G-61231 23G, 5 pcs. per box

G-61251 25G, 5 pcs. per box

SINGLE-USE ENDO-PROBE S UNO COLORLINE

straight, plug for IRIDEX® Laser, sterile



G-61204 20G, 5 pcs. per box

G-61234 23G, 5 pcs. per box

G-61254 25G, 5 pcs. per box

SINGLE-USE ENDO-PROBE C UNO COLORLINE

curved, plug for GEUDER endoTRON, sterile



G-61202 20G, 5 pcs. per box

G-61232 23G, 5 pcs. per box

G-61252 25G, 5 pcs. per box

SINGLE-USE ENDO-PROBE C UNO COLORLINE

curved, plug for IRIDEX® Laser, sterile



G-61205 20G, 5 pcs. per box

G-61235 23G, 5 pcs. per box

G-61255 25G, 5 pcs. per box

20G RED: 20 GAUGE / 0.9 MM

23G GREEN: 23 GAUGE / 0.6 MM

25G BLUE: 25 GAUGE / 0.5 MM

TROCAR SYSTEMS

HATTENBACH / NIKOLIC

SINGLE-USE TROCAR SYSTEM ONE-STEP UNO COLORLINE

3 ports for one-step technique,
incl. infusion tubing, sterile

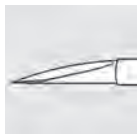

G-42011 20G, 1 set per box
G-46011 20G, 6 sets per box

G-42311 23G, 1 set per box
G-46311 23G, 6 sets per box

G-42511 25G, 1 set per box
G-46511 25G, 6 sets per box

SINGLE-USE TROCAR PLUGS UNO COLORLINE

G-42019 20G, 1 set (3 pcs.) per box

G-42319 23G, 1 set (3 pcs.) per box



FIBER OPTICS

SINGLE-USE FIBER OPTIC S UNO COLORLINE

spot, sterile



G-42021 20G, 1 pcs. per box
G-46021 20G, 6 pcs. per box

G-42321 23G, 1 pcs. per box
G-46321 23G, 6 pcs. per box

G-42521 25G, 1 pcs. per box
G-46521 25G, 6 pcs. per box

SINGLE-USE FIBER OPTIC W UNO COLORLINE

wide angle, sterile

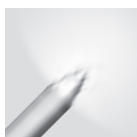

G-42022 20G, 1 pcs. per box
G-46022 20G, 6 pcs. per box

G-42322 23G, 1 pcs. per box
G-46322 23G, 6 pcs. per box

G-42522 25G, 1 pcs. per box
G-46522 25G, 6 pcs. per box

20G RED: 20 GAUGE / 0.9 MM

23G GREEN: 23 GAUGE / 0.6 MM

25G BLUE: 25 GAUGE / 0.5 MM

**SINGLE-USE FIBER OPTIC WS
UNO COLORLINE**
wide angle, shielded, sterile



G-42023 20G, 1 pcs. per box
G-46023 20G, 6 pcs. per box

G-42323 23G, 1 pcs. per box
G-46323 23G, 6 pcs. per box

G-42523 25G, 1 pcs. per box
G-46523 25G, 6 pcs. per box

VITREOUS CUTTERS

**SINGLE-USE HIGH SPEED VITREOUS CUTTER
UNO COLORLINE**
pneumatic, with GEUDER safety-connector,
sterile



G-42001 20G, 1 pcs. per box
G-46001 20G, 6 pcs. per box

G-42301 23G, 1 pcs. per box
G-46301 23G, 6 pcs. per box

G-42501 25G, 1 pcs. per box
G-46501 25G, 6 pcs. per box

**SINGLE-USE HIGH SPEED VITREOUS CUTTER
MACH 2 UNO COLORLINE**
Doubleblade, pneumatic,
with GEUDER safety-connector, sterile



G-42002 20G, 1 pcs. per box
G-46002 20G, 6 pcs. per box

G-42302 23G, 1 pcs. per box
G-46302 23G, 6 pcs. per box

G-42502 25G, 1 pcs. per box
G-46502 25G, 6 pcs. per box

**SINGLE-USE INFUSION TUBE 20G
UNO COLORLINE**
for 20 gauge GEUDER
UNO Colorline vitreous cutters, sterile
G-42009 20G, 1 pcs. per box





- G-34340** **SINGLE-USE EYE SPECULUM**
with aspiration, 2 x 4 aspiration ports
fenestrated, open blades
5 pcs. per box, sterile



SZURMAN

- SINGLE-USE DMEK-CARTRIDGE**
for Descemet Membrane Endothelial Keratoplasty
incl. Tube connection for loading
the cartridge, sterile

- G-38630** incision 3 mm, 14 gauge / 2.0 mm
G-38635 incision 2.4 to 2.75 mm, 16 gauge / 1.6 mm

- G-34523** **SINGLE-USE IRIS RETRACTOR**
for mechanical dilation of the pupil, flexible
4 iris retractors per set, 2 sets per box, sterile



- G-34810** **LACRIMAL INTUBATION TUBING**
silicone tubing 35 cm
OD 0.6 mm, ID 0.3 mm
10 pcs. per box, sterile



- G-34811** **LACRIMAL INTUBATION SET**
suture with silicone tubing
0.6 mm
10 pcs. per box, sterile



G-34812 LACRIMAL INTUBATION SET
 silicone tubing 0.6 mm
 2 probes 110 mm with olive tips
 27 gauge / 0.4 mm
 3 pcs. per box, sterile



G-34814 DCR LACRIMAL INTUBATION SET
 silicone tubing 0.6 mm, 2 probes 45 mm
 20 gauge / 0.9 mm
 3 pcs. per box, sterile



G-34290 SINGLE-USE LACRIMAL CANNULA
 curved 26 gauge / 0.45 x 30 mm
 10 pcs. per box, sterile



G-34200 SINGLE-USE RETROBULBAR CANNULA
 10 pcs. per box, sterile
 25 gauge, 0.5 x 40 mm
G-34205
 26 gauge, 0.45 x 50 mm



ATKINSON
G-34210 SINGLE-USE RETROBULBAR CANNULA
 10 per box, sterile
 25 gauge, 0.5 x 40 mm
G-34215
 23 gauge, 0.64 x 40 mm



G-34220 SINGLE-USE PERIBULBAR CANNULA
 25 gauge, 0.5 x 30 mm
 10 pcs. per box, sterile



G-34225 SINGLE-USE CYSTOTOME CANNULA
 vaulted, 45°
 25 gauge / 0.5 mm
 10 pcs. per box, sterile
G-34230
 12.5 mm long, side cutting
 12.5 mm long



G-34261

LEWICKY

SINGLE-USE A. C. MAINTAINER

20 gauge / 0.9 mm, tip 5 mm
3 pcs. per box, sterile

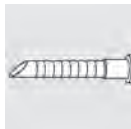

G-34235

RYCROFT

SINGLE-USE A. C. CANNULA

angled at 5 mm, 45°

10 pcs. per box, sterile

20 gauge, 0.9 x 5 + 17 mm

G-34240

25 gauge, 0.5 x 25 mm



G-34245

SAUTTER

SINGLE-USE HYDRODISSECTION CANNULA

vertically flattened

27 gauge / 0.4 x 22 mm

10 pcs. per box, sterile



G-34270

TUEBINGEN MODEL

SINGLE-USE HYDRODISSECTION CANNULA

30 gauge / 0.3 x 22 mm

10 pcs. per box, sterile



G-34271

FRANKFURT MODEL

SINGLE-USE HYDRODISSECTION CANNULA

27 gauge / 0.4 mm

10 pcs. per box, sterile



CANNULAS (A.C. MAINTAINER, RYCROFT, HYDRODISSECTION)

G-34265 **SINGLE-USE IRRIGATION VECTIS CANNULA**
 double port
 25 gauge / 0.5 mm
 10 pcs. per box, sterile



G-34255 *KRATZ*
SINGLE-USE CAPSULE POLISHING CANNULA
 angled at 9 mm, 45°
 closed tip with sideport, textured
 23 gauge / 0.6 mm
 10 pcs. per box, sterile



G-34280 *SIMCOE*
SINGLE-USE I/A CANNULA
 0.4 mm diameter aspiration port
 front opening irrigation port
 23 gauge / 0.64 mm
 10 pcs. per box, sterile



G-15197 **SINGLE-USE IRRIGATION CANNULA**
 for viscocanalostomy
 26 gauge / 0.45 mm shaft
 35 gauge / 0.21 mm angled tip
 5 mm tapered tube
 5 pcs. per box, sterile



G-34335 **SINGLE-USE IRRIGATION CANNULA**
 for topical irrigation
 with bulbous tip, straight
 length 60 mm, 3 mm diameter tip
 50 pcs. per box, sterile



G-80975 **SINGLE-USE INJECTION CANNULA**
 for EasyGas®
 30 gauge / 0.3 x 12 mm
 100 pcs. per box, sterile





G-34400 SINGLE-USE BIMANUAL I/A HANDPIECE SET

consisting of:
 · Irrigation Handpiece, irrigation ports 2 x 0.6 mm
 · Aspiration Handpiece, aspiration port 0.4 mm
 · rough tip tube 21 gauge / 0.8 mm
 5 pcs. per box, sterile

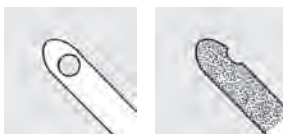

G-34289 SINGLE-USE BACKFLUSH HANDPIECE

with silicone chamber, Luer-Lock
 10 pcs. per box, sterile



G-34806 SINGLE-USE SILICONE CHAMBER

for backflush handpieces G-31805,
 G-37000 and G-37002
 10 pcs. per box, sterile



G-34275 SINGLE-USE BACKFLUSH CANNULA

inside diameter 25 gauge / 0.5 mm
 outside diameter 21 gauge / 0.8 x 35 mm
 10 pcs. per box, sterile



SINGLE-USE BACKFLUSH CANNULA

blunt tip
 5 pcs. per box, sterile

G-34291

20 gauge / 0.9 mm

G-34296

23 gauge / 0.6 mm

G-34299

25 gauge / 0.5 mm



SINGLE-USE BACKFLUSH CANNULA

with silicone brush
 5 pcs. per box, sterile

G-34293

20 gauge / 0.9 mm

G-34294

23 gauge / 0.6 mm

G-34297

25 gauge / 0.5 mm



SINGLE-USE BACKFLUSH CANNULA

with silicone tip
5 pcs. per box, sterile
G-34292 20 gauge / 0.9 mm
G-34295 23 gauge / 0.6 mm
G-34298 25 gauge / 0.5 mm



G-34285 SINGLE-USE PFCL CANNULA

for injection of heavy fluids
dual bore, coaxial
23 gauge / 0.64 mm
10 pcs. per box, sterile



SINGLE-USE CANNULA

to inject silicone oil
10 pcs. per box, sterile
G-34497 20 gauge / 0.9 mm x 8 mm
G-34498 23 gauge / 0.6 mm x 8 mm



G-33482 SINGLE-USE INJECTION CANNULA

for viscous fluids, self-retaining, 4.0 mm tip
with 25 cm PVC tube
Luer-Lock plastic adapter
20 gauge / 0.9 mm
5 pcs. per box, sterile



G-33463 SINGLE-USE INFUSION CANNULA

self-retaining, 4.0 mm tip
with 25 cm silicone tube
Luer-Lock plastic adapter
20 gauge / 0.9 mm
5 pcs. per box, sterile



SINGLE-USE INFUSION CANNULA

with 25 cm silicone tube
Luer-Lock plastic adapter
20 gauge / 0.9 mm
5 pcs. per box, sterile



G-33468 beveled tip, 4.0 mm

G-33469 beveled tip, 6.0 mm

G-33462 SINGLE-USE INFUSION CANNULA

4.0 mm beveled tip
with 25 cm PVC tube
Luer-Lock plastic adapter
25 gauge / 0.5 mm
10 pcs. per box, sterile



CANNULAS (BACKFLUSH WITH SILICONE TIP, PFCL, SILICONE OIL, INFUSION)

SINGLE-USE INJECTION CANNULA

for viscous fluids
with 1 metal sleeve, Luer-Lock plastic adapter
and 25 cm PVC tube
20 gauge / 0.9 mm
5 pcs. per box, sterile
beveled tip, 4.0 mm
G-33488
beveled tip, 6.0 mm
G-33489



G-34480

SINGLE-USE INJECTION CANNULA

for viscous fluids
4.0 mm beveled tip
with 2 metal sleeves, Luer-Lock plastic adapter
and 25 cm silicone tube
19 gauge / 1.1 mm
10 pcs. per box, sterile



G-34492

KIRCHHOF

SINGLE-USE INJECTION CANNULA

for gas / viscous fluids
5.0 mm beveled tip with 4 infusion side ports
2 metal sleeves, Luer-Lock plastic adapter and
40 cm silicone tube
20 gauge / 0.9 mm
10 pcs. per box, sterile



G-32696

SINGLE-USE PRESSURE TUBE

for injection of viscous fluid, Luer-Lock female / male
10 pcs. per box, sterile



G-31891

SINGLE-USE SYRINGE

Luer-Lock, 10 ml, sterile



G-31520

SINGLE-USE MINI FILTER

0.1 µm, sterile



CANNULAS (INJECTION, VISCOUS FLUIDS, GAS)

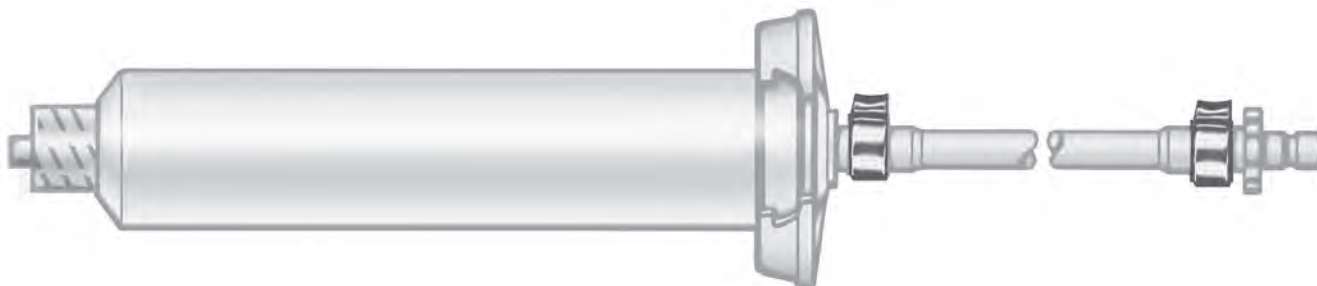

G-28766 **SINGLE-USE OIL INJECTION SYSTEM**
to inject silicone oil pneumatically,
with protective cover for glass syringe,
pressure tube fits megaTRON® S3 / S4 HPS and
Pentasy® 2, sterile

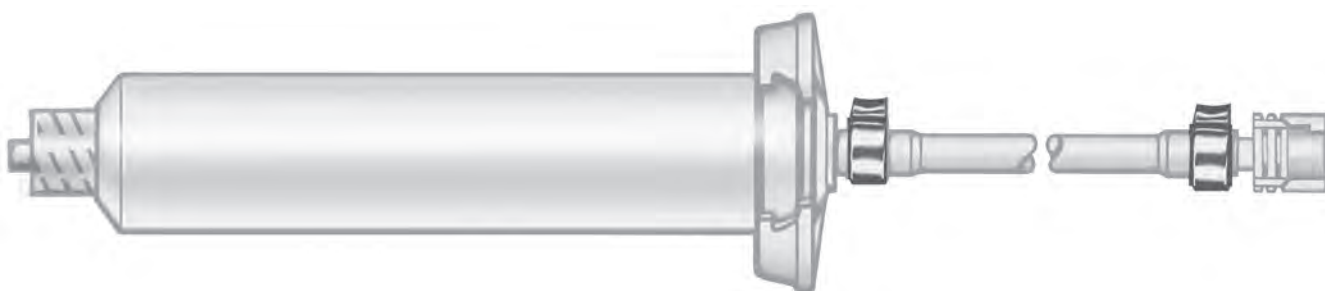

G-28767 **SINGLE-USE OIL INJECTION SYSTEM**
to inject silicone oil pneumatically,
with protective cover for glass syringe,
pressure tube fits megaTRON® and Accurus® ,sterile

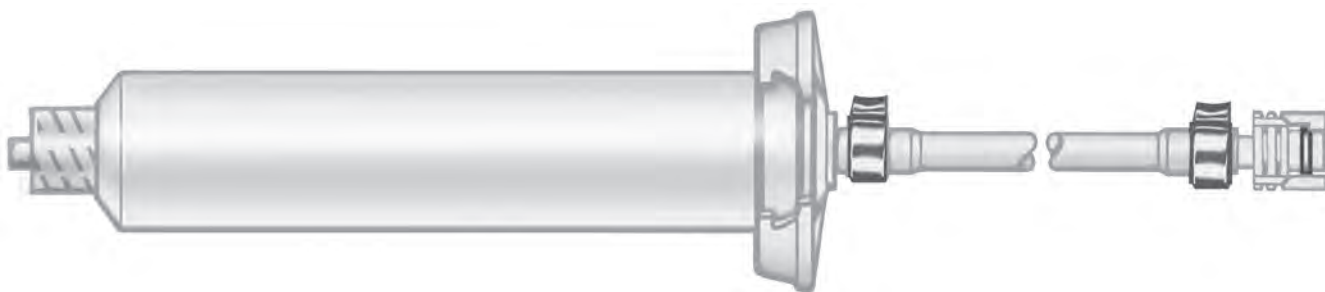

G-28768 **SINGLE-USE OIL INJECTION SYSTEM**
to inject silicone oil pneumatically,
with protective cover for glass syringe,
pressure tube fits Millennium® , sterile

- G-23991** **SINGLE-USE THREE-WAY STOP COCK**
2x Luer-Lock female, 1x Luer-Lock male
plastic, sterile



- G-32700** **SCALPEL HANDLE**

SCALPEL SURGICAL BLADES

100 pcs. per box, sterile

- G-32705** #11, curved cutting edge

- G-32710** #15, straight edge and pointed tip



- G-18127** **ABSORBENT SWABS**
17 mm long
box of 20 pouches
10 swabs per pouch
sterile

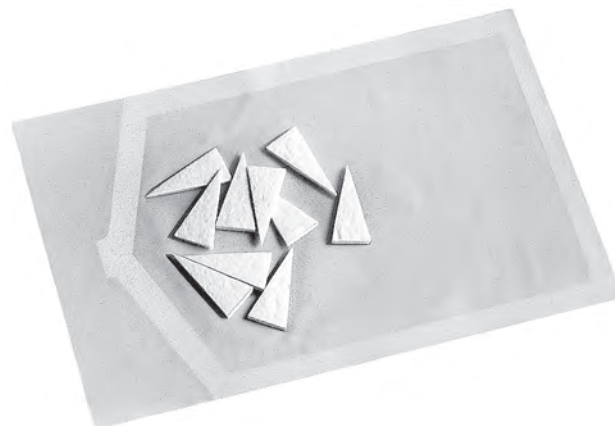

- G-33786** **MARKING PEN**
gentian violet
dual tip, fine and broad
to ink corneal instruments
20 pcs. per box, sterile



G-34602 SILICONE TIRE (276 STYLE)
 asymmetrical, 7.0 mm wide
 2.5 mm groove
 5 pcs. per box, sterile

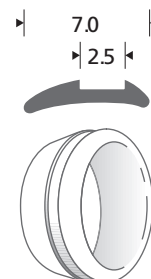

G-34610 SILICONE TIRE (287 STYLE)
 convex, 7.0 mm wide
 2.5 mm groove
 5 pcs. per box, sterile

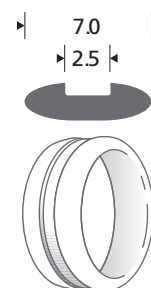

G-34616 SILICONE TIRE (277 STYLE)
 concave, 7.0 mm wide
 2.5 mm groove
 5 pcs. per box, sterile

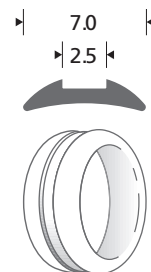

G-34618 SILICONE TIRE (279 STYLE)
 concave, 9.0 mm wide
 2.5 mm groove
 5 pcs. per box, sterile

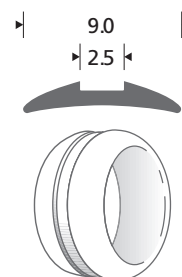

G-34620 SILICONE CIRCLING BAND (40 STYLE)

0.75 mm x 2.0 mm
125 mm long
5 pcs. per box, sterile

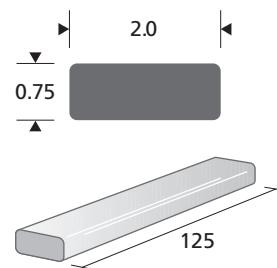
**G-34622 SILICONE CIRCLING BAND (240 STYLE)**

0.6 mm x 2.5 mm
125 mm long
5 pcs. per box, sterile

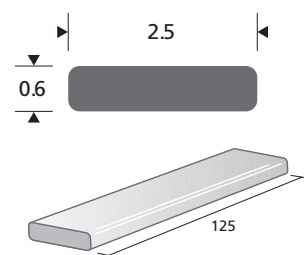
**G-34624 SILICONE STRIP (41 STYLE)**

0.75 mm x 3.5 mm
125 mm long
5 pcs. per box, sterile

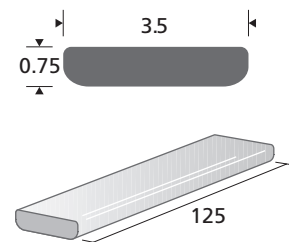
**G-34626 SILICONE STRIP (42 STYLE)**

1.25 mm x 4.0 mm
125 mm long
5 pcs. per box, sterile

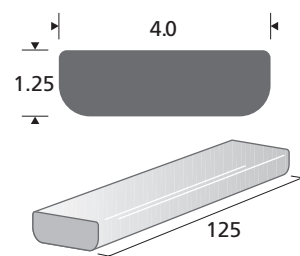

G-34632 **GROOVED SILICONE STRIP (31 STYLE)**
 2.0 mm x 4.5 mm
 125 mm long, 2.0 mm groove
 5 pcs. per box, sterile

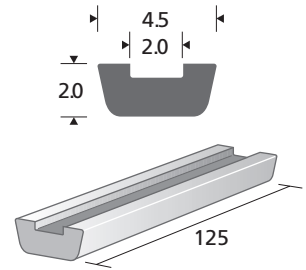

G-34634 **GROOVED SILICONE STRIP (32 STYLE)**
 2.5 mm x 5.0 mm
 125 mm long, 2.0 mm groove
 5 pcs. per box, sterile

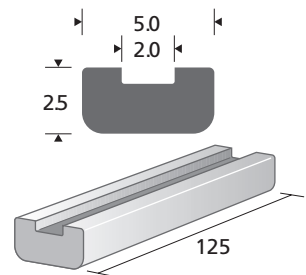

G-34636 **GROOVED SILICONE STRIP (219 STYLE)**
 1.25 mm x 4.5 mm
 100 mm long, 2.5 mm groove
 5 pcs. per box, sterile

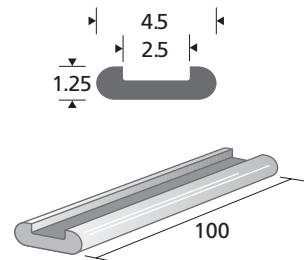

G-34644 **SILICONE SLEEVE (72 STYLE)**
 1.5 mm inside diameter
 2.4 mm outside diameter
 30 mm long
 5 pcs. per box, sterile

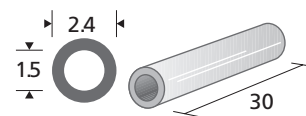

G-34642 **SILICONE SLEEVE (70 STYLE)**
 1.0 mm inside diameter
 2.1 mm outside diameter
 30 mm long

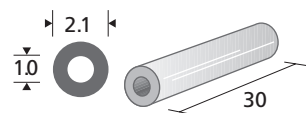

G-34646 **SILICONE SLEEVE (270 STYLE)**
 0.76 mm inside diameter
 1.65 mm outside diameter
 30 mm long
 5 pcs. per box, sterile

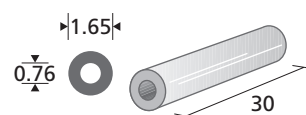

G-34645 OVAL SILICONE SLEEVE (3083 STYLE)

1.5 mm inside diameter
2.5 mm outside diameter
5 mm long
5 pcs. per box, steril

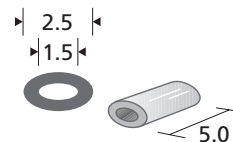

G-34647 OVAL SILICONE SLEEVE (3084 STYLE)

1.5 mm inside diameter
3.75 mm outside diameter
5 mm long
5 pcs. per box, steril

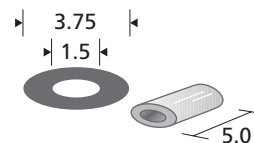

G-34654 SILICONE WEDGE (137 STYLE)

2.5 mm groove
5 pcs. per box, sterile

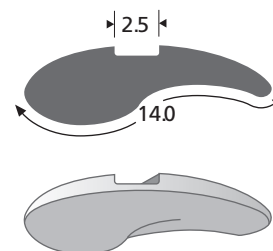

G-34650 MERIDIONAL SILICONE IMPLANT (106 STYLE)

6.5 mm wide
10.5 mm long
5 pcs. per box, sterile

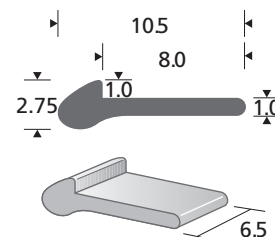

G-34656 ROUND SILICONE SPONGE IMPLANT (503 STYLE)

3.0 mm diameter
80 mm long
5 pcs. per box, sterile

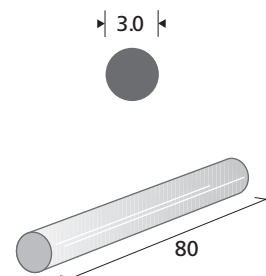

G-34658 ROUND SILICONE SPONGE IMPLANT (504 STYLE)

4.0 mm diameter
80 mm long
5 pcs. per box, sterile

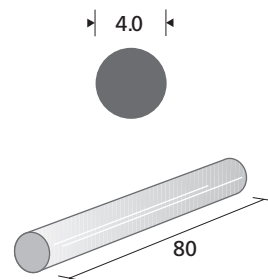

G-34660 ROUND SILICONE SPONGE IMPLANT (505 STYLE)

5.0 mm diameter
80 mm long
5 pcs. per box, sterile

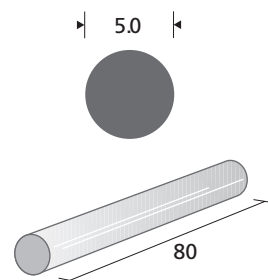

G-34664 OVAL SILICONE SPONGE IMPLANT (501 STYLE)

2.5 mm x 4.0 mm
80 mm long
5 pcs. per box, sterile

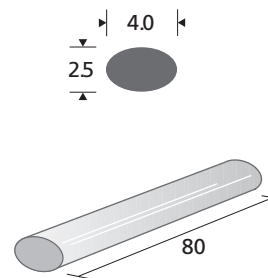

G-34666 OVAL SILICONE SPONGE IMPLANT (506 STYLE)

3.0 mm x 5.0 mm
100 mm long
5 pcs. per box, sterile

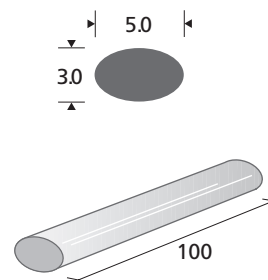

G-34668 OVAL SILICONE SPONGE IMPLANT (507 STYLE)

5.5 mm x 7.5 mm
80 mm long
5 pcs. per box, sterile

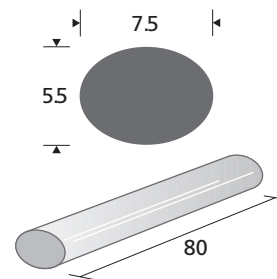
**G-34672 GROOVED SILICONE SPONGE IMPLANT (506G STYLE)**

3.0 mm x 5.0 mm
80 mm long, 2.5 mm groove
5 pcs. per box, sterile

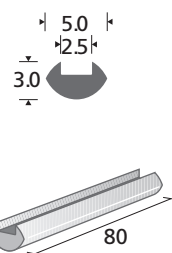
**G-34674 GROOVED SILICONE SPONGE IMPLANT (507G STYLE)**

5.5 mm x 7.5 mm
80 mm long, 2.5 mm groove
5 pcs. per box, sterile

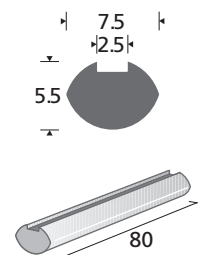
**G-34684 SEMI-CIRCULAR SILICONE SPONGE IMPLANT (510 STYLE)**

2.5 mm x 5.0 mm
80 mm long
5 pcs. per box, sterile

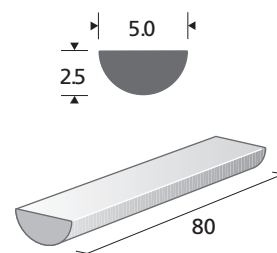

G-34686 SEMI-OVAL SILICONE SPONGE IMPLANT (511 STYLE)

2.75 mm x 7.5 mm
80 mm long
5 pcs. per box, sterile

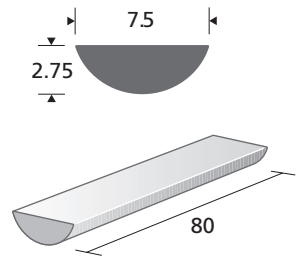

G-34688 SEMI-OVAL SILICONE SPONGE IMPLANT (515 STYLE)

3.33 mm x 5.0 mm
80 mm long
5 pcs. per box, sterile

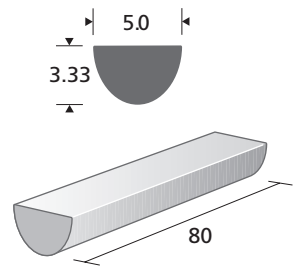

G-34690 SEMI-OVAL SILICONE SPONGE IMPLANT (517 STYLE)

3.66 mm x 7.5 mm
80 mm long
5 pcs. per box, sterile

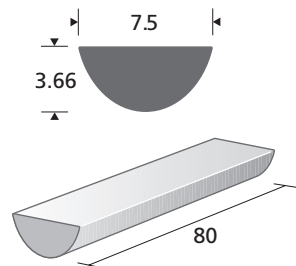

G-34710 BONN INJECTION SET

single-use set for intravitreal injection
consisting of:

- measuring and fixation instrument, 3.5 / 4.0 mm
 - eye speculum
 - irrigation cannula
 - cannula 0.9 x 70 mm
 - syringe 1 ml
 - syringe 10 ml
 - eye drape with pre-cut adhesive incise-film 140 x 140 cm
 - absorbent swab (3x)
 - gauze compress 10 x 10 (2x)
 - protective cover 60 x 60 cm
- 10 pcs. per box, sterile



MISCELLANEOUS



CAPSULE TENSION RING INJECTORS.....	241
PUPIL DILATOR INJECTOR.....	241
LACRIMAL / DCR.....	242
LASEK.....	243
DIAMOND BURR.....	244
VITRECTOMY LENSES.....	244
EYE SHIELD.....	245
EYE SPHERES.....	245
CAUTERY.....	246



G-32955

INJECTOR

for capsular tension ring
shaft diameter 1.2 mm
for 1.9 mm incisions
shaft length 30 mm
overall length 156 mm



G-32960

INJECTOR

for *MORCHER* capsular tension ring
shaft diameter 1.2 mm
for 1.9 mm incisions
shaft length 30 mm
overall length 156 mm



G-32965

INJECTOR

for *MORCHER* capsular ring
shaft diameter 1.6 mm
for 2.4 - 2.5 mm incisions
shaft length 30 mm
overall length 156 mm

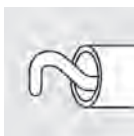

G-32970

INJECTOR

for *MORCHER* pupil dilator
overall length 140 mm



G-31810 *FRIEDMANN*
RONGEUR
overall length 140 mm



G-32355 **NASAL SPECULUM**
overall length 150 mm



G-33125 *MEAD*
HAMMER
300 g, lead filled
overall length 190 mm



G-18630 *HEIDELBERG MODEL*
ELEVATORIUM
overall length 143 mm



G-18620 *HEIDELBERG MODEL*
RASPATORY
overall length 155 mm





G-18240 *WEST*
BONE CHISEL
for lacrimal sac
flat, 5.0 mm wide
overall length 160 mm



G-18245 *WEST*
BONE GOUGE
for lacrimal sac
concave, 5.0 mm wide
overall length 162 mm



ELSA
LASEK TREPHINE
with crosshairs
overall length 100 mm
G-33650 8.0 mm
G-33652 9.0 mm



LOHMANN
LASEK FUNNEL
with crosshairs
overall length 100 mm
G-33655 8.5 mm
G-33657 9.5 mm



G-32313 *WRIGHT*
FASCIA NEEDLE
overall length 115 mm

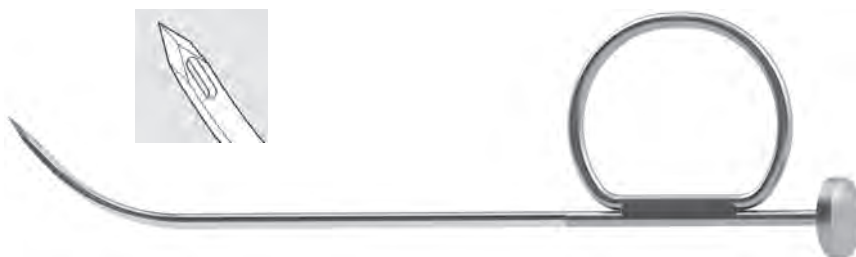

DIAMOND BURR

- G-18300 top, inside, outside coat
8.0 mm
- G-18301 9.0 mm
- G-18302 10.0 mm



-
- G-36000 *KILP*
LENS
60 D flat, field of vision 20°, silicone ring
central posterior pole and central vitreous body



-
- G-36010 *LANDERS*
LENS
93 D, biconcave with silicone ring
clear view of fundus in air-filled phakic eye



-
- G-36015 *MACHEMER*
LENS
with silicone ring to magnify structures
in vitreous cavity or on retinal surface



-
- G-36020 *PEYMAN*
LENS
wide field of vision 30°, with silicone ring
for central fundus and central vitreous body



-
- G-36025 *TOLENTINO*
LENS
prism 20° with silicone ring
posterior peripheral fundus and
posterior peripheral vitreous body



-
- G-36030 *TOLENTINO*
LENS
prism 30° with silicone ring
peripheral viewing beyond the equator



-
- G-36045 **SILICONE REPLACEMENT RING**
for *KILP* lens G-36000



DIAMOND BURR · VITRECTOMY LENSES

G-36050 SILICONE REPLACEMENT RING
for lenses from G-36010 to G-36035



G-36065 LENS HANDLE RING
for lenses without silicone ring
to suture on to sclera
for G-36000



G-31105 EYESHIELD
plastic, transparent for use on both eyes
100 pcs. per bag



CIBIS
EYE SPHERE

G-20216 16 mm
G-20217 17 mm
G-20218 18 mm
G-20219 19 mm
G-20220 20 mm



HARMS
EYE SPHERE

G-20316 16 mm
G-20317 17 mm
G-20318 18 mm
G-20319 19 mm
G-20320 20 mm



WALSER
EYE SPHERE

G-20416 16 mm
G-20417 17 mm
G-20418 18 mm
G-20419 19 mm
G-20420 20 mm

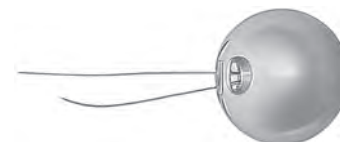

G-19820 **BATTERY CAUTERY**
 with spare tip
 and batteries
 overall length with
 spare tip 155 mm



9/10

G-19825 **SPARE TIP**
 for battery cauterization G-19820
 overall length 50 mm



G-31900 *KUHN*
INTRAOCULAR MAGNET
 30 mm shaft, 1.9 mm outside diameter
 4 mm magnetic tip
 overall length 90 mm



STERILIZATION CONTAINERS AND ADAPTERS



MICROSTOP [®]	249
STEEL CASES	252
TRAYS & RACKS FOR STEEL CASES	256
SILICONE STRIPS & MATS	257
SMALL CASES	258
STERISAFE [®] DURO	259
ADAPTERS	264

G-39745 **MICROSTOP[®]**
CONTAINER LOW
for one tray
outside dimensions: 310 x 189 x 70 mm
inside dimensions: 283 x 177 x 50 mm



G-39750 **MICROSTOP[®]**
CONTAINER HIGH
for two trays
outside dimensions: 310 x 189 x 90 mm
inside dimensions: 283 x 177 x 70 mm



MICROSTOP[®]
TRAY MINI
29 mm, low
size: 277 x 172 x 29 mm
G-39783 without lid
G-39786 with lid



MICROSTOP[®]
TRAY MINI
38 mm, high
size: 277 x 172 x 38 mm
G-39785 without lid
G-39784 with lid



MICROSTOP[®]

G-39787 **MICROSTOP®**
TRAY LID MINI
 size: 277 x 172 mm
 for G-39783 and G-39785

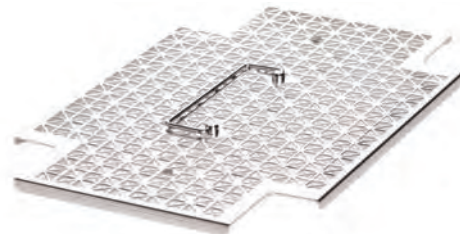

G-39782 **MICROSTOP®**
RETAINER ELEMENT
 for MICROSTOP® tray mini
 nap Style, 120 mm
 separable into 6 single elements
G-39789 29 mm, low
 38 mm, high



G-39788 **MICROSTOP®**
CLIP FOR RETAINER ELEMENTS
 G-39782 and G-39789
 10 pcs. per bag



G-39791 **MICROSTOP®**
ID LABEL
 for tray, aluminium
 customized labeling
 silver-colored



G-39741 **MICROSTOP®**
LABEL
 for lid, customized labeling



G-39746 **MICROSTOP®**
ID LABEL
 for front, customized labeling



**MICROSTOP[®]
LOGISTIC FRAME**
for lid to use with labels

- G-39753** color: red
- G-39754** color: blue
- G-39755** color: green



G-39762 **MICROSTOP[®]
SEAL**
with indicator
1000 pcs. per box

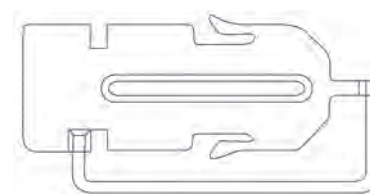

G-39764 **MICROSTOP[®]
TAG**
with indicator
1000 pcs. per box



G-39680 **PROTOCOL CARDS**
for ERGO-SAFE tray
320 pcs. per box



G-19822

STERILIZATION CASE

- for steam sterilization
- outside dimensions: 220 x 165 x 55 mm
- textile filter in lid and base
- silicone seal
- perforated insert without edge
- perforated silicone tray G-32785
- 2 labels with clamp



G-19823

STERILIZATION CASE

- for steam sterilization
- outside dimensions: 220 x 165 x 75 mm
- textile filter in lid and base
- silicone seal
- perforated insert without edge
- perforated silicone tray G-32785
- 2 labels with clamp



G-28151

STERILIZATION CASE

- for steam sterilization
- outside dimensions: 300 x 220 x 75 mm
- textile filter in lid and base
- silicone seal
- perforated insert without edge
- 3 silicone burl strips
- 2 silicone paddings in lid
- 2 labels with clamp



G-28150

STERILIZATION CASE

- for steam sterilization
- outside dimensions: 300 x 220 x 75 mm
- textile filter in lid and base
- silicone seal in the lid
- perforated insert with edge, subdivided, with perforated silicone plate and perforated silicone tray
- silicone insert, small, with perforated silicone tray
- 2 labels with clamp



G-19876**STERILIZATION CASE**

- for steam sterilization
 outside dimensions: 300 x 220 x 55 mm
- textile filter in lid and base
 - silicone seal
 - perforated insert without edge
 - 3 silicone burl strips
 - 2 silicone paddings in lid
 - 2 labels with clamp

**G-19856****STERILIZATION CASE**

- for steam sterilization
 outside dimensions: 300 x 220 x 55 mm
- paper filter with quick-clasp in lid and base
 - silicone seal in the lid
 - without insert and profile strips
 - 2 labels with clamp

**G-19843****STERILIZATION CASE**

- for steam sterilization
 outside dimensions: 300 x 220 x 75 mm
- textile filter in lid and base
 - silicone seal
 - perforated insert with edge
 - perforated silicone plate
 - perforated insert without edge
 - 3 silicone burl strips
 - 2 silicone paddings in lid
 - 2 labels with clamp



G-19842

STERILIZATION CASE

- for steam sterilization
 outside dimensions: 300 x 220 x 75 mm
- textile filter in lid and base
 - silicone seal in the lid
 - perforated insert with edge and perforated silicone plate
 - perforated insert with edge perforated silicone plate and silicone instrument tray
 - 2 labels with clamp



G-19877

STERILIZATION CASE

- for steam sterilization
 outside dimensions: 400 x 290 x 55 mm
- textile filter in lid and base
 - silicone seal
 - perforated insert without edge
 - 4 silicone burl strips
 - 3 silicone paddings in lid
 - 2 labels with clamp



G-19892

STERILIZATION CASE

- for steam sterilization
 outside dimensions: 400 x 290 x 70 mm
- textile filter in lid and base
 - silicone seal in the lid
 - 2 perforated inserts without edge with 4 silicone nap strips each
 - 3 silicone profile strips at the base of the upper perforated insert
 - 3 silicone profile strips in the lid
 - 2 labels with clamp



G-19894

STERILIZATION CASE

- for steam sterilization
- outside dimensions: 400 x 290 x 70 mm
- textile filter in lid and base
- silicone seal in the lid
- perforated insert without edge with 4 silicone nap strips
- perforated insert with edge and silicone nap plate
- 3 silicone profile strips in the lid
- 2 labels with clamp

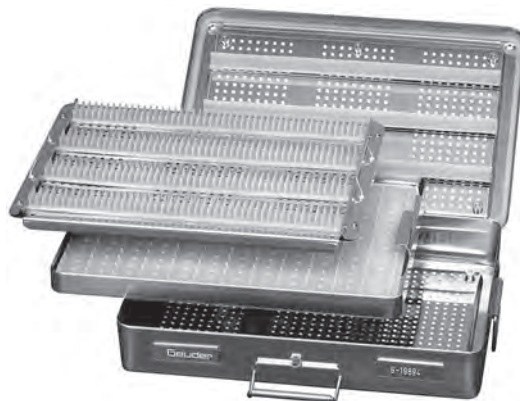

G-19890

STERILIZATION CASE

- for steam sterilization
- outside dimensions: 495 x 270 x 70 mm
- textile filter in lid and base
- silicone seal in the lid
- perforated insert with edge 4 silicone nap strips and lateral compartment (240 x 110 x 40 mm),
- 3 silicone profile strips in the lid
- 2 labels with clamp



PERMANENT TEXTILE FILTER

for steam sterilization cases

G-31650

for G-19822, G-19823

G-31651

for G-19841, G-19842, G-19843, G-19876, G-28150, G-28151

G-31652

6 perforations, for G-19877, G-19892, G-19894

G-31656

for G-19877

G-31661

for G-19890



G-31649

INDICATOR

for steam sterilization, slim
1000 pcs. per box

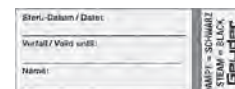

G-32675 **SILICONE TRAY**
with bottom
outside dimensions: 160 x 85 x 20 mm



G-32660 **STERILIZATION RACK**
for 12 cannulas, silicone
outside dimensions: 85 x 56 x 8 mm



G-19870 **STERILIZATION RACK**
for 10 instruments with handle, silicone
outside dimensions: 160 x 85 x 20 mm

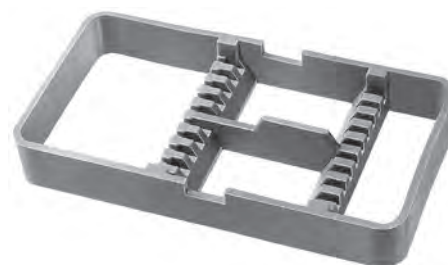

G-32785 **SILICONE PERFORATED TRAY**
outside dimensions: 194 x 135 x 24 mm

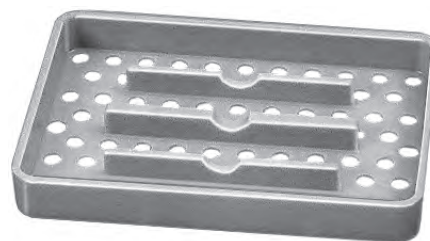

G-39650 **STERILIZATION CASE**
for steam sterilization, plastic
for 6 vitreoretinal instruments
outside dimensions: 210 x 130 x 26 mm



G-32676 **SILICONE NAP STRIP BLUE**
340 x 30 mm



G-32677 **SILICONE STRIP BLUE**
350 mm long



SILICONE BURL MAT
perforated
G-19866 240 x 230 mm
G-19865 300 x 150 mm
G-19867 470 x 245 mm



G-19899 **SILICONE PLATE**
perforated, 270 x 185 mm
for hot air sterilization cases
G-19841, G-19842, G-19843,
G-19846, G-19847

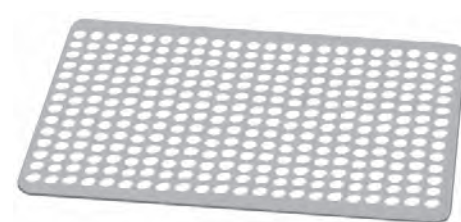

SILICONE STRIPS & SILICONE MATS

G-31657 SAFETY SEAL
for steam sterilization cases
100 pcs. per box



G-31659 SEAL
for hot-air sterilization cases
100 pcs. per box



G-32695 SILICONE CLOSURE
17 cm long



G-33080 STERILIZATION CASE
for steam sterilization, plastic, for 5 instruments with handle
outside dimensions: 160 x 85 x 20 mm



G-33090 STERILIZATION CASE
for one instrument or diamond knife, plastic
outside dimensions: 160 x 60 x 20 mm



G-33100 STERILIZATION CASE
for one vitreoretinal instrument, plastic
outside dimensions: 195 x 60 x 25 mm

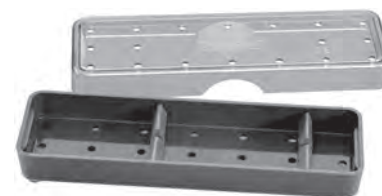

G-36090 **STERILIZATION CASE**
plastic, for 6 vitreoretinal lenses



G-39527 **STERISAFE[®] DURO A4 PLUS**
container for steam, gas (EO, FO) and plasma
sterilization, without trays and strips
outside dimensions: 290 x 190 x 70 mm
inside dimensions: 265 x 165 x 60 mm



G-39526 **STERISAFE[®] DURO A4 PLUS COMPLETE SET**
container for steam, gas (EO, FO) and plasma
sterilization, including:
1 x Sterisafe[®] wire basket A4-30
5 x Sterisafe[®] silicone retainer strips 230 mm
1 x Sterisafe[®] metal tray A4-30
outside dimensions: 290 x 190 x 70 mm
inside dimensions: 265 x 165 x 60 mm

G-39525 **STERISAFE[®] DURO A4**
container for steam, gas (EO, FO) and plasma
sterilization
outside dimensions: 290 x 190 x 60 mm
inside dimensions: 265 x 165 x 49 mm



G-39528 **STERISAFE[®] DURO A6**
container for steam, gas (EO, FO) and plasma
sterilization
outside dimensions: 190 x 110 x 60 mm
inside dimensions: 165 x 92 x 49 mm



STERISAFE[®] DURO

G-39543 STERISAFE® DURO WIRE BASKET A4-30

outside dimensions: 260 x 163 x 30 mm
inside dimensions: 249 x 157 x 23 mm



G-39541 STERISAFE® DURO METAL TRAY A4-15

outside dimensions: 260 x 163 x 15 mm
inside dimensions: 249 x 157 x 11 mm



G-39542 STERISAFE® DURO METAL TRAY A4-30

outside dimensions: 260 x 163 x 30 mm
inside dimensions: 249 x 157 x 26 mm



G-39549 STERISAFE® DURO WIRE BASKET A6-30

outside dimensions: 162 x 90 x 30 mm
inside dimensions: 156 x 80 x 23 mm



G-39548 STERISAFE® DURO METAL TRAY A6-15

outside dimensions: 162 x 90 x 15 mm
inside dimensions: 156 x 80 x 11 mm



G-39545 **STERISAFE[®] SILICONE RETAINER STRIP 75**
for Sterisafe[®] DURO A4 and A6
length: 75 mm



G-39546 **STERISAFE[®] SILICONE RETAINER STRIP 145**
for Sterisafe[®] DURO A4 and A6
length: 145 mm



G-39547 **STERISAFE[®] SILICONE RETAINER STRIP 230**
for Sterisafe[®] DURO A4 and A6
length: 230 mm



G-39501 **STERISAFE[®] FILTER**
A4 10 pcs. per box
G-39511 A6 10 pcs. per box



G-39530 **STERISAFE[®] FILTER TAG EXPIRATION DATE**
10 pcs. per box



G-39535 **SEAL / LABEL**
seal with color indicator and blank label
2000 pcs. per box

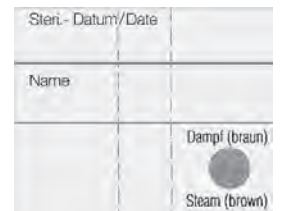

STERISAFE[®] DURO

G-39540 **SECURITY SEAL**
100 pcs. per box



G-39502 **STERISAFE® SILICONE BURL MAT** A4
G-39512 A6

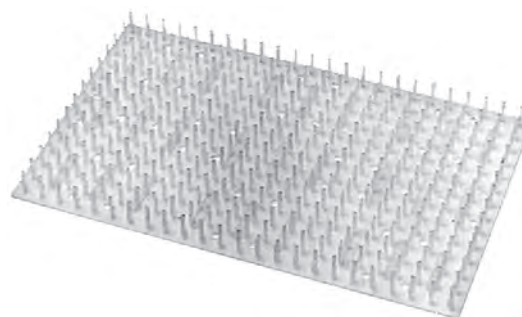

G-39503 **STERISAFE® SILICONE GRID INSERT** A4
G-39513 A6

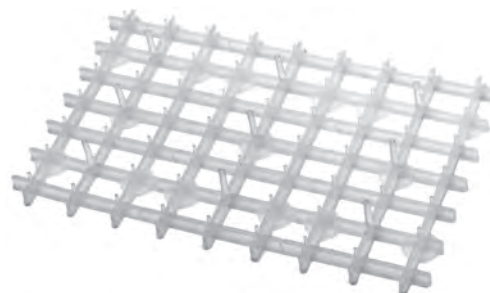

G-39504 **STERISAFE® METAL GRID INSERT** A4
G-39514 A6



STERISAFE® DURO

G-39505 **STERISAFE[®] METAL GRID INSERT**
with 2 silicone burl strips

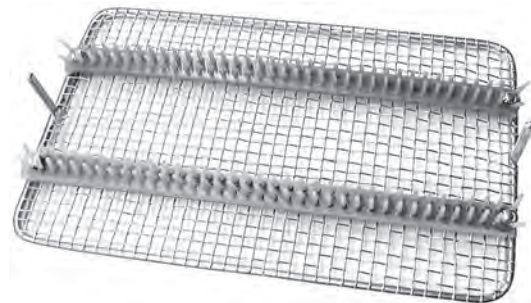

G-31670 **MELAG METAL GRID INSERT**
with 2 silicone nap strips
outside dimensions: 370 x 147 x 50 mm
for MELAG sterilizing case

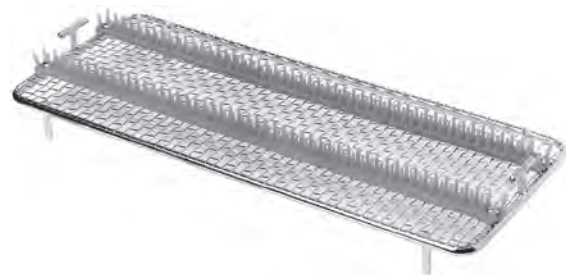

G-31028 **CLEANING ADAPTER**
 for ultrasonic handpieces (irrigation connector)
 Luer female / male



G-31029 **CLEANING ADAPTER**
 for ultrasonic handpieces (aspiration connector)
 Luer female / female



G-31021 **CLEANING ADAPTER**
 for ultrasonic tips



G-31013 **CLEANING ADAPTER**
 for *HATTENBACH* 25 gauge hybrid instruments
 (G-32944, G-32947 and G-32948)

G-22636 **ADAPTER**
 for *PAPST* I/A handpiece
 light model



G-31025 **ASPIRATION ADAPTER**
 metal
 for cleaning I/A handpieces
 Luer-Lock female / female



G-31026 **ASPIRATION ADAPTER**
 plastic
 for cleaning I/A handpieces
 Luer-Lock female / female



G-31016 **CLEANING ADAPTER**
for diamond knives, small



G-31017 **CLEANING ADAPTER**
for diamond knives, large



G-31022 **CLEANING ADAPTER**
for G-37010 - G-37080



G-31031 **CLEANING ADAPTER**
for aspiration handpiece G-37100 and G-37105
Luer-Lock female / silicone tube
2.1 x 1.0 mm



G-31018 **CLEANING ADAPTER**
for PFCL cannula G-33055
Luer-Lock female / silicone tube



G-31024 **CLEANING ADAPTER**
for eye specula with aspiration



G-31023 **CLEANING ADAPTER**
for eye specula with aspiration
G-33141, G-33142 and G-33143



G-31027 **CLEANING ADAPTER**
for *JUENEMANN* probes





G-31034 **CLEANING ADAPTER**
for foreign body instruments G-14530, G-14540, G-14550
Luer-Lock female

G-31014 **CLEANING ADAPTER**
for cannulas G-33057 and G-33059
Luer-Lock female



G-36604 **CLEANING ADAPTER**
for rotatable and interchangeable tips



PLEASE READ YOUR INSTRUMENT'S
CLEANING INSTRUCTIONS OR ASK
YOUR LOCAL SALES REPRESENTATIVE
FOR THE RIGHT CLEANING ADAPTER.

19

SETS

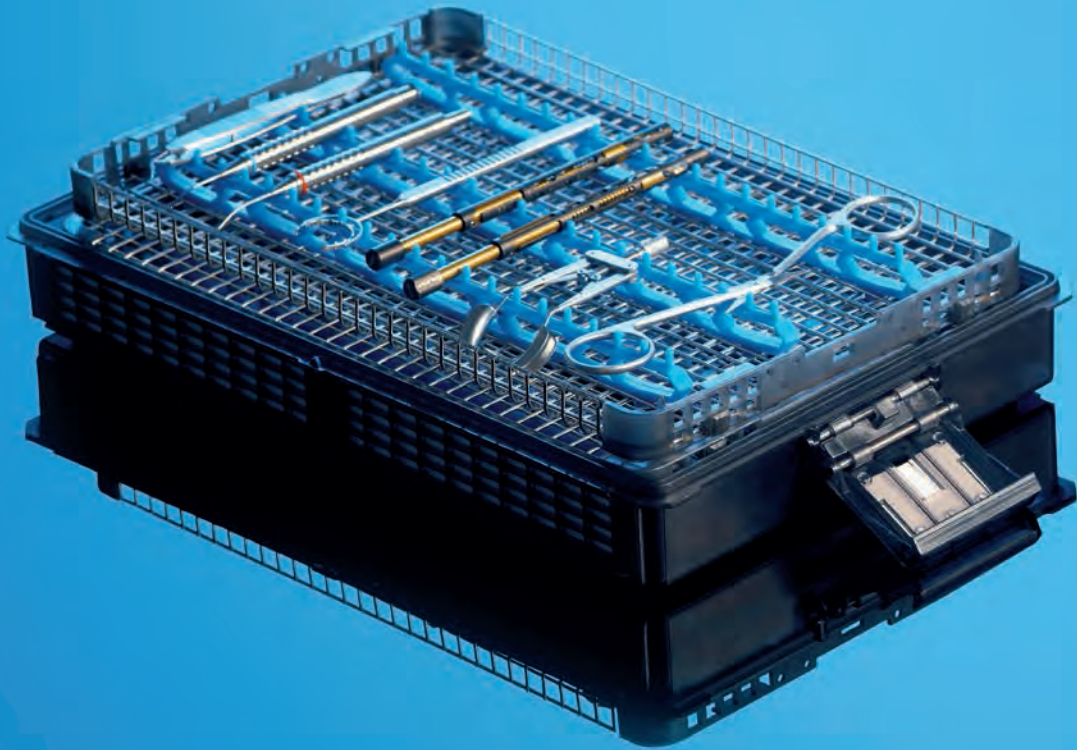

Geuder[®]
Precision made in Germany

ECCE - EXTRA CAPSULAR CATARACT EXTRACTION

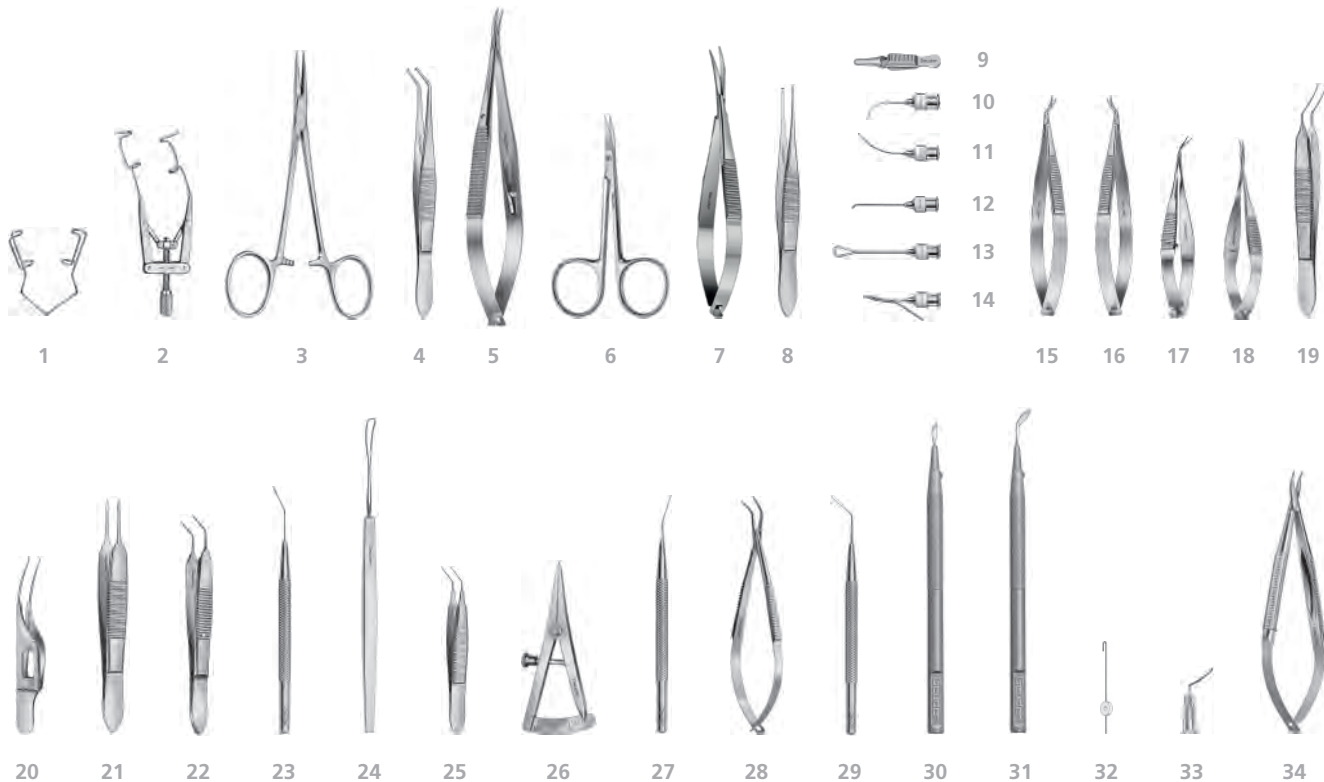

		page			page
1	G-17020 <i>BARRAQUER EYE SPECULUM</i> fenestrated.....	15	20	G-18960 <i>MICRO COLIBRI FORCEPS</i> with tying platform.....	104
2	G-15960 <i>LIEBERMANN-TENNANT EYE SPECULUM</i>	25	21	G-19030 <i>TUEBINGEN TYING FORCEPS</i> straight.....	106
3	G-18180 <i>HALSTEAD MOSQUITO FORCEPS</i> straight.....	135	22	G-19032 <i>TYING FORCEPS</i> angled, 7.5 mm.....	107
4	G-18820 <i>REMKY SUPERIOR RECTUS FORCEPS</i>	125	23	G-16189 <i>SPATULA</i> angled, 0.5 mm wide.....	159
5	G-17575 <i>CASTROVIEJO NEEDLE HOLDER</i> curved, w. lock.....	142	24	G-15620 <i>ARLT LENS LOOP</i> serrated.....	161
6	G-19400 <i>BONN EYE SCISSORS</i> curved, delicate.....	92	25	G-18910 <i>BONN IRIS FORCEPS</i> angled, 8.0 mm, 1 x 2 teeth.....	110
7	G-19750 <i>WESTCOTT SCISSORS</i> blunt tips, curved, 12 cm.....	89	26	G-19130 <i>CASTROVIEJO CALIPER</i> 15 mm.....	43
8	G-18791 <i>DRESSING FORCEPS</i> 1 x 2 teeth, 0.7 mm.....	110	27	G-16175 <i>DARDENNE IRIS HOOK</i> push-pull.....	157
9	G-18190 <i>DIEFFENBACH SERREFINE</i> straight, 35 mm.....	136	28	G-18935 <i>DODEN IMPLANTATION FORCEPS</i>	121
10	G-15185 <i>FRANKFURT HYDRODISSECTION CANNULA</i> 27G.....	192	29	G-16167 <i>SINSKEY LENS MANIPULATION HOOK</i> 0.2 mm.....	156
11	G-15250 <i>SAUTTER HYDRODIS. CANNULA</i> 27G, vert flat.....	192	30	G-34026 <i>NANOEDGE PARACENTESIS KNIFE</i> 15° straight.....	217
12	G-16125 <i>KRATZ CAPSULE POLISHING CANNULA</i>	195	31	G-34146 <i>NANOEDGE IMPLANT KNIFE</i> angled, 6 mm.....	217
13	G-16115 <i>IRRIGATION VECTIS CANNULA</i>	193	32	G-34523 <i>SINGLE-USE IRIS RETRACTOR</i> flexible, 2 x 4 pcs.....	223
14	G-16106 <i>SIMCOE I/A CANNULA</i> 23G, dual shaft.....	194	33	G-34225 <i>SINGLE-USE CYSTOTOME CANNULA</i>	224
15	G-19710 <i>TROUTMAN CORNEAL SCISSORS</i> right, curved.....	81	34	G-17500 <i>BARRAQUER NEEDLE HOLDER</i> curved, w/o lock.....	139
16	G-19715 <i>TROUTMAN CORNEAL SCISSORS</i> left, curved.....	81	35	G-39786 <i>MICROSTOP® TRAY MINI</i> low, with lid.....	249
17	G-19776 <i>CAPSULOTOMY SCISSORS</i> angled up.....	83	36	G-39783 <i>MICROSTOP® TRAY MINI</i> low, without lid.....	249
18	G-19765 <i>VANNAS CAPSULOTOMY SCISSORS</i> curved.....	84	37	G-39782 <i>MICROSTOP® RETAINER ELEMENT</i> low.....	250
19	G-31305 <i>CAPSULORHEXIS FORCEPS</i> extra delicate.....	114	38	G-39750 <i>MICROSTOP® CONTAINER HIGH</i> for two trays.....	249

PHACO / CATARACT



	page		page
1 G-15960	25	18 G-32926	115
2 G-32148	16	CAPSULORHEXIS FORCEPS flat handle.....	
3 G-34210	224	19 G-31305	114
4 G-15250	192	20 G-31720	120
5 G-15151	189	21 G-31507	152
6 G-15200	191	22 G-16167	156
7 G-19023	103	23 G-19030	106
8 G-33758	150	24 G-19032	107
9 G-19485	89	25 G-17500	139
10 G-34026	217	26 G-19130	43
11 G-34055	217	27 G-31901	124
12 G-34051	217	28 G-19400	92
13 G-34052	217	29 G-22100	198
14 G-18960	104	30 G-22101	199
15 G-32162	154	31 G-39786	249
and NUCLEUS DIVIDING HOOK		32 G-39783	249
16 G-19765	84	33 G-39782	250
17 G-16189	159	34 G-39750	249

PHACO EMERGENCY

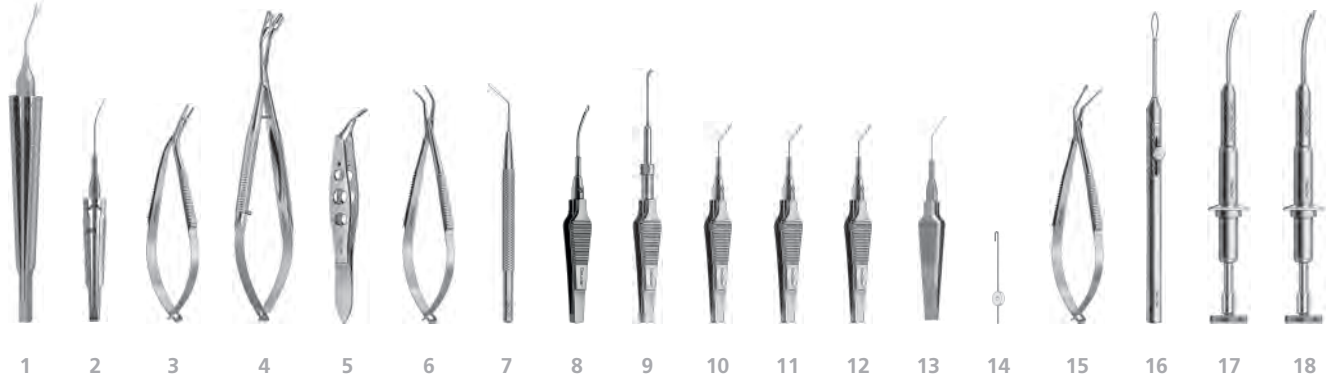

	page		page
1 G-32996 SNYDER-OSHER IOL SCISSORS 18G/1.2mm, long.....	88	11 G-32947 HATTENBACH HYBRID TYING FORCEPS 25G.....	108
2 G-32997 SNYDER-OSHER IOL FORCEPS 22G / 0.7 mm.....	125	12 G-32948 HATTENBACH HYBRID SCISSORS 25G.....	86
3 G-32945 STEINMETZ IOL SCISSORS.....	87	13 G-32949 HATTENBACH HYBRID NEEDLE HOLDER angled.....	143
4 G-31994 H.-R. KOCH PREFOLDER for foldable IOLs.....	124	14 G-34523 SINGLE-USE IRIS RETRACTOR flexible, 2 x 4 pcs.....	223
5 G-31905 H.-R. KOCH FOLDER for 3-piece IOLs.....	124	15 G-32823 EXPLANTATION FORCEPS for soft IOLs.....	125
6 G-18935 DODEN IMPLANTATION FORCEPS.....	121	16 G-32800 H.-R. KOCH SILICONE LENS BI-SECTOR.....	88
7 G-16167 SINSKEY LENS MANIPULATION HOOK 0.2 mm.....	156	17 G-32960 INJECTOR for MORCHER capsule tension ring.....	241
8 G-32935 H.-R. KOCH CAPSULE FORCEPS shaft 22G.....	115	18 G-32970 INJECTOR for MORCHER pupil dilator.....	241
9 G-32940 H.-R. KOCH CAPSULE SCISSORS 45° angled.....	85	19 G-39526 STERISAFE DURO A4 PLUS COMPLETE SET.....	259
10 G-32944 HATTENBACH CAPSULORHEXIS FORCEPS angled.....	117		

MSICS - MANUAL SMALL INCISION CATARACT SURGERY

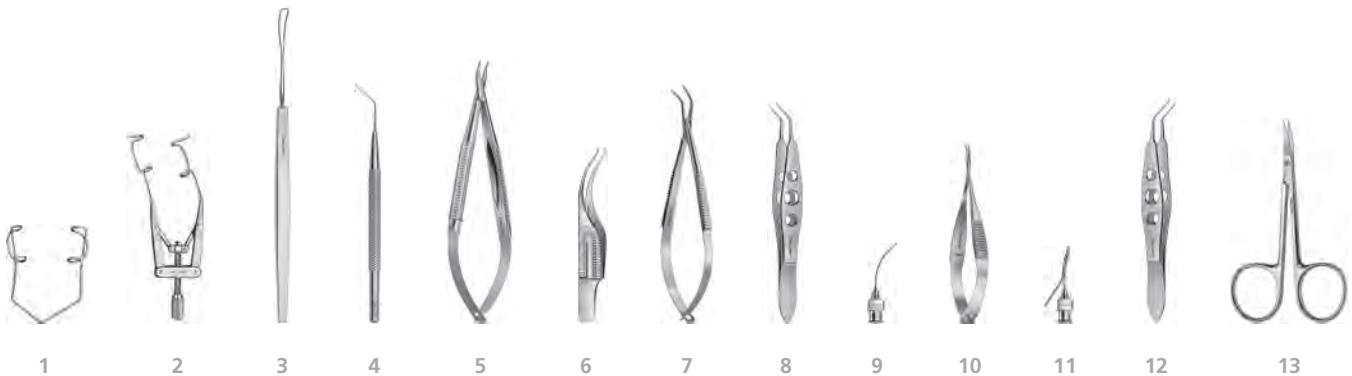

	page		page
1 G-32136 BARRAQUER EYE SPECULUM fenest., round.....	16	8 G-31622 GASKIN FRAGMENT FORCEPS angled, 9.0 mm.....	108
2 G-15960 LIEBERMANN-TENNANT EYE SPECULUM.....	25	9 G-15250 SAUTTER HYDRODIS. CANNULA 27G, vert flat.....	192
3 G-15620 ARLT LENS LOOP serrated, 3.5 mm wide.....	161	10 G-19765 VANNAS CAPSULOTOMY SCISSORS curved.....	84
4 G-16167 SINSKEY LENS MANIPULATION HOOK 0.2 mm.....	156	11 G-16106 SIMCOE I/A CANNULA 23G, dual shaft.....	194
5 G-17500 BARRAQUER NEEDLE HOLDER curved, w/o lock.....	139	12 G-31307 CAPSULORHEXIS FORCEPS strong.....	113
6 G-18950 COLIBRI FORCEPS with tying platform.....	104	13 G-19400 BONN EYE SCISSORS curved, delicate.....	92
7 G-18935 DODEN IMPLANTATION FORCEPS.....	121		

PHACO EMERGENCY / MSICS - MANUAL SMALL INCISION CATARACT SURGERY

MICS - MICRO INCISION CATARACT SURGERY



1 2 3 4 5 6 7 8 9

	page		page
1 G-38448 DIACLEAN CCI DIAMOND KNIFE trapez. 1.5/2.0.....	60	6 G-32012 IRRIGATION HANDPIECE 2x0.5 mm, con., text., 21G.....	200
2 G-32926 AUFFARTH MICS CAPSULORHEXIS FORCEPS	115	7 G-32011 ASPIRATION HANDPIECE 0.3 mm port, 21G.....	200
3 G-38240 JAPAN HANDLE for capsule forceps and scissors.....	116	8 G-31507 NAGAHARA NUCLEUS DIVIDING HOOK	152
4 G-38244 IKEDA CAPSULORHEXIS FORCEPS 23G, micro-tips.....	116	9 G-32505 TH. NEUHANN NUCLEUS DIVIDING HOOK	151
5 G-38246 YAE CAPSULE SCISSORS 23G, interchangeable.....	85		

FLACS - FEMTOSECOND LASER-ASSISTED CATARACT SURGERY



1 2 3 4 5 6 7 8 9

	page		page
1 G-33965 DICK FEMTOCATARACT EYE SPECULUM	26	6 G-15250 SAUTTER HYDRODIS. CANNULA 27G, vert flat.....	192
2 G-33966 DICK FEMTOCATARACT SPATULA double ended....	169	7 G-34245 SAUTTER SINGLE-USE HYDRODISSECTION	
3 G-33967 BREYER FEMTOCATARACT SPATULA blunt tip.....	169	CANNULA	225
4 G-33968 HOFFMANN FEMTOCATARACT NUCLEUS		8 G-22100 KOCH-KOHNEN ASPIRATION HANDPIECE 22G.....	198
ROTATOR AND CHOPPER	169	9 G-22101 KOCH-KOHNEN IRRIGATION HANDPIECE 22G.....	199
5 G-32926 AUFFARTH MICS CAPSULORHEXIS FORCEPS	115	10 G-39526 STERISAFE DURO A4 PLUS COMPLETE SET	259

**SNYDER-OSHER
IOL EXPLANTATION**



1 2

	page
1 G-32997 SNYDER-OSHER IOL FORCEPS 22G / 0.7 mm.....	125
2 G-32998 SNYDER-OSHER IOL SCISSORS 18G/1.2mm, short.....	88

TORIC IOL



1 2 3 4 5 6 7

	page
1 G-33777 TOMARK ADJUSTABLE CORNEAL MARKER.....	47
2 G-33776 TOMARK PENDULUM INSTRUMENT handheld.....	47
3 G-33774 SCOTT CORNEAL PENDULUM MARKER.....	46
4 G-33763 GERTEN HORIZONTAL AXIS MARKER.....	46
5 G-16130 CAPSULE POLISHING CANNULA 18G / 1.2 mm.....	195
6 G-32564 RENTSCH CAPSULE POLISHING CURETTE 90°.....	160
7 G-33786 MARKING PEN gentian violet, 20 pcs./box.....	231

HATTENBACH IRIS SUTURE



1 2 3

	page
1 G-32949 HATTENBACH HYBRID NEEDLE HOLDER angled.....	143
2 G-32947 HATTENBACH HYBRID TYING FORCEPS 25G.....	108
3 G-32948 HATTENBACH HYBRID SCISSORS 25G.....	86

SNYDER-OSHER IOL EXPLANTATION · TORIC IOL · HATTENBACH IRIS SUTURE

LASEK - LASER-ASSISTED EPITHELIAL KERATOMILEUSIS

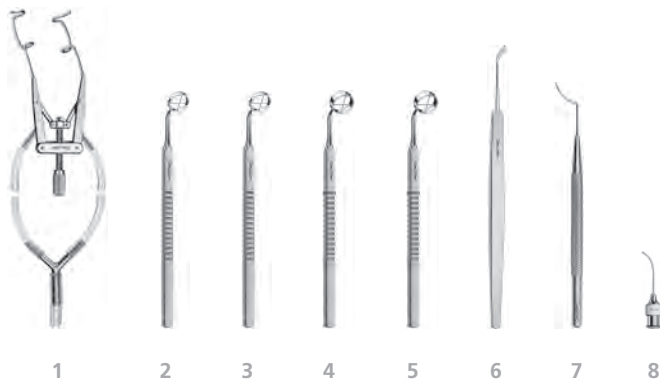

	page		page
1 G-15961 <i>LIEBERMANN-TENNANT</i> ASPIRATION SPECULUM.....	28	5 G-33657 <i>LOHMANN</i> LASEK FUNNEL 9.5 mm, w crosshairs.....	243
2 G-33650 LASEK TREPHINE 8.0 mm, with crosshairs.....	243	6 G-33670 <i>LOHMANN</i> LASEK EPI PEELER.....	167
3 G-33652 LASEK TREPHINE 9.0 mm, with crosshairs.....	243	7 G-33930 <i>TH. NEUHANN</i> LASIK SPATULA.....	167
4 G-33655 <i>LOHMANN</i> LASEK FUNNEL 8.5 mm, w crosshairs.....	243	8 G-15180 IRRIGATION CANNULA bulbous tip, 26G.....	194

LASIK - LASER-ASSISTED IN SITU KERATOMILEUSIS



	page		page
1 G-33920 <i>KNORZ</i> LASIK EYE SPECULUM w aspiration.....	26	10 G-18914 <i>BURATTO</i> LASIK FLAP FORCEPS.....	119
2 G-15960 <i>LIEBERMANN-TENNANT</i> EYE SPECULUM.....	25	11 G-33943 <i>PFAEFFL</i> FLAP LIFTER V-shaped lifter and hook.....	171
3 G-33745 <i>MENDEZ</i> LASIK CORNEAL MARKER.....	46	12 G-33912 <i>ZIRM</i> LASIK CORNEAL PROTECTOR.....	167
4 G-33746 <i>CHAYET</i> LASIK CORNEAL MARKER.....	46	13 G-33940 <i>BLUM</i> FEMTO-LASIK ROUND SPOON bevel up.....	170
5 G-33747 <i>LU</i> LASIK CORNEAL MARKER.....	45	14 G-33759 <i>FINE-THORNTON</i> FIXATION RING 13 mm, blunt.....	150
6 G-33910 <i>ZIRM</i> LASIK DISSECTOR CANNULA 25G, flat.....	197	15 G-33786 MARKING PEN gentian violet, 20 pcs./box.....	231
7 G-33911 <i>ZIRM</i> LASIK IRRIGATION CANNULA 20G, flat.....	197	16 G-18150 HOLDER FOR ABSORBENT STRIPS.....	145
8 G-33909 <i>BAUER</i> LASIK CANNULA double-armed, 25G.....	196	17 G-18127 ABSORBENT SWABS 17 mm, sterile.....	231
9 G-33428 <i>PFAEFFL</i> FLAPORHEXIS FORCEPS oval tips.....	118	18 G-39526 <i>STERISAFE DURO A4 PLUS</i> COMPLETE SET.....	259

FEMTO LASIK

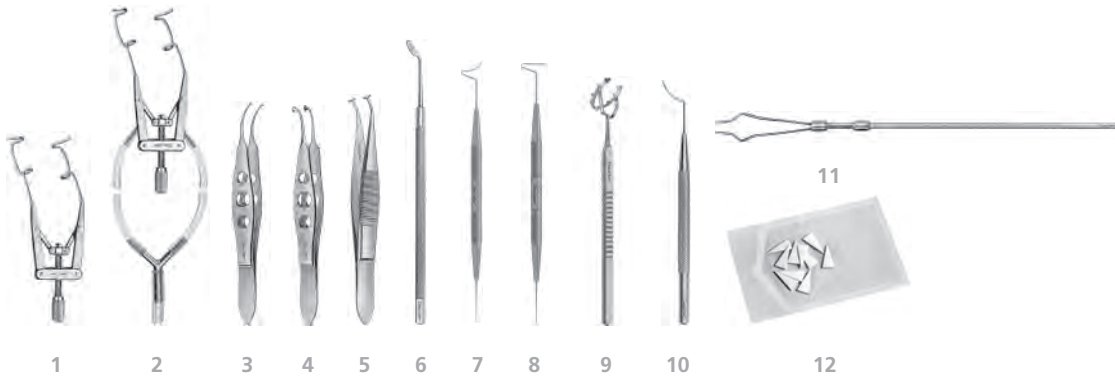

1	G-15960	LIEBERMANN-TENNANT EYE SPECULUM	25	7	G-33427	PFAEFFL FLAP LIFTER curved lifter and hook.....	171
2	G-15961	LIEBERMANN-TENNANT ASPIRATION SPECULUM	28	8	G-33943	PFAEFFL FLAP LIFTER V-shaped lifter and hook.....	171
3	G-18914	BURATTO LASIK FLAP FORCEPS	119	9	G-33758	CLEAR-CORNEA-INCISION FIXATION RING	150
4	G-33428	PFAEFFL FLAPORHEXIS FORCEPS oval tips.....	118	10	G-33930	TH. NEUHANN LASIK SPATULA	167
5	G-33429	KNORZ FEMTO-LASIK FLAP FORCEPS T-bar tips.....	118	11	G-18150	HOLDER FOR ABSORBENT STRIPS	145
6	G-33912	ZIRM LASIK CORNEAL PROTECTOR	167	12	G-18127	ABSORBENT SWABS 17 mm, sterile.....	231

RELEX® SMILE - SMALL INCISION LENTICULE EXTRACTION

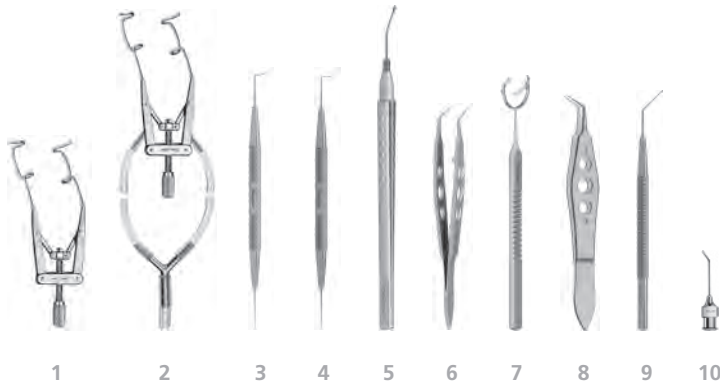

			page				page
1	G-15960	LIEBERMANN-TENNANT EYE SPECULUM	25	5	G-33960	RUPAL SHAH LENTICULE MICRO FORCEPS	119
2	G-15961	LIEBERMANN-TENNANT ASPIRATION SPECULUM	28	6	G-33961	LENTICULE FORCEPS angled to side, 7.5 mm.....	119
3	G-33952	CHANSUE FEMTO DOUBLE INSTRUMENT spatula/hook.....	170	7	G-33759	FINE-THORNTON FIXATION RING 13 mm, blunt.....	150
4	G-33950	CHANSUE FEMTO DOUBLE INSTRUMENT spoon-spatula/hook.....	169	8	G-33941	KELMAN-MCPHERSON FRAGMENT FORCEPS	108
				9	G-33959	BREYER FEMTO-LASIK HOOK	171
				10	G-33910	ZIRM LASIK DISSECTOR CANNULA 25G, flat.....	197

*ReLex® (Refractive Lenticule Extraction) is a registered trademark of Carl ZeissMeditec AG.

KERATOPLASTY

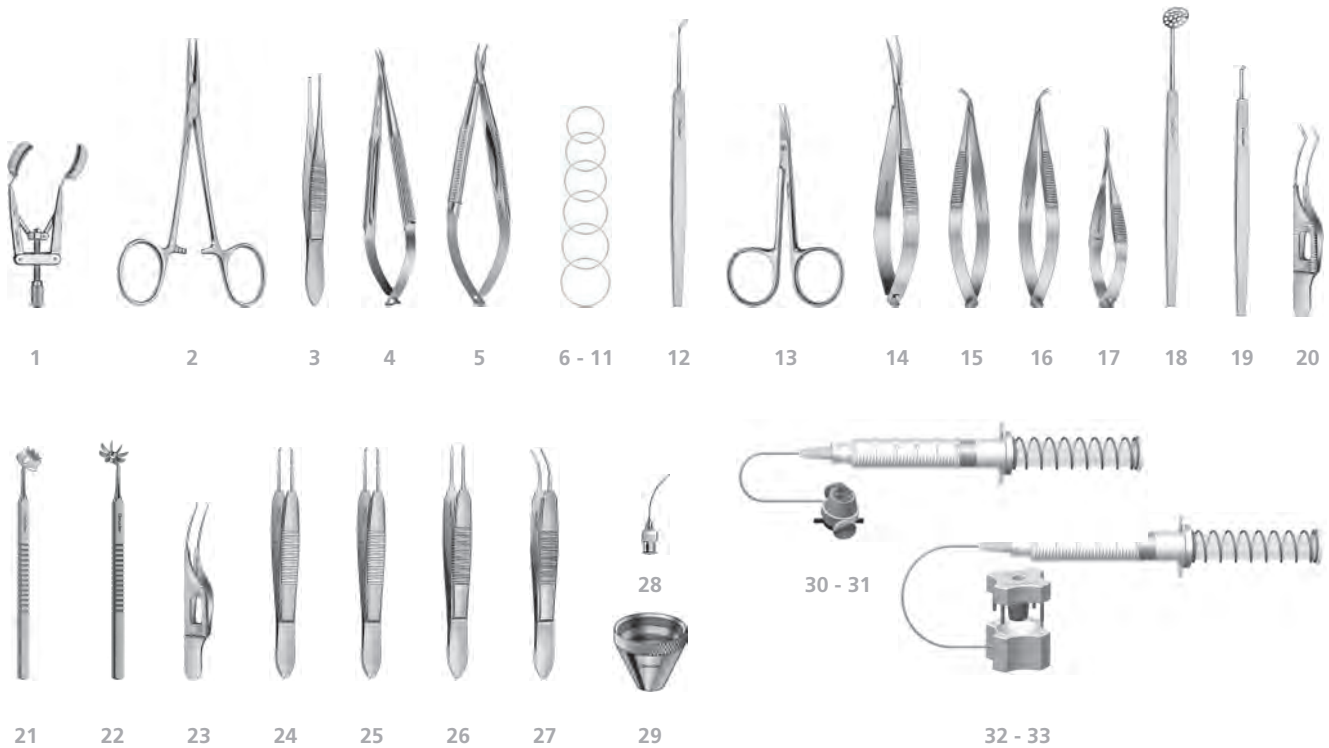

	page		page
1 G-15966 KERSHNER EYE SPECULUM solid blades.....	25	18 G-15758 KERATOPLASTY SPATULA perforated.....	163
2 G-18180 HALSTEAD MOSQUITO FORCEPS straight.....	135	19 G-14200 PAUFIQUE KERATOPLASTY KNIFE.....	64
3 G-18791 DRESSING FORCEPS 1 x 2 teeth, 0.7 mm.....	110	20 G-18972 THOMAS NEUHANN KERATOPLASTY FORCEPS.....	104
4 G-17450 JACOBI NEEDLE HOLDER curved, w/o lock.....	139	21 G-32229 DUNCKER SUTURE MARKER for 8.0 mm transplant...42	
5 G-17500 BARRAQUER NEEDLE HOLDER curved, w/o lock.....	139	22 G-33727 THOMAS NEUHANN CORNEAL MARKER 8 blades...41	
6 G-15065 FLIERINGA FIXATION RING 15 mm.....	150	23 G-18960 MICRO COLIBRI FORCEPS with tying platform.....	104
7 G-15070 FLIERINGA FIXATION RING 16 mm.....	150	24 G-19001 CASTROVIEJO SUTURING FORCEPS 0.12 mm.....	103
8 G-15075 FLIERINGA FIXATION RING 17 mm.....	150	25 G-19010 CASTROVIEJO SUTURING FORCEPS 0.6 mm.....	103
9 G-15080 FLIERINGA FIXATION RING 18 mm.....	150	26 G-19030 TUEBINGEN TYING FORCEPS straight.....	106
10 G-15085 FLIERINGA FIXATION RING 19 mm.....	150	27 G-19040 TUEBINGEN TYING FORCEPS curved.....	106
11 G-15090 FLIERINGA FIXATION RING 20 mm.....	150	28 G-15250 SAUTTER HYDRODIS. CANNULA 27G, vert flat.....	192
12 G-14020 KUHNT CORNEAL SCARIFIER fig. 2.....	64	29 G-32318 MALONEY KERATOMETER.....	45
13 G-19400 BONN EYE SCISSORS curved, delicate.....	92	30 G-570750 NANOEDGE VACUUM TREPHINE 7.5 mm.....	216
14 G-19750 WESTCOTT SCISSORS blunt tips, curved, 12 cm.....	89	31 G-570800 NANOEDGE VACUUM TREPHINE 8.0 mm.....	216
15 G-19720 KATZIN KERATOPLASTY SCISSORS right, 10 cm.....	81	32 G-560800 NANOEDGE VACUUM CORNEAL PUNCH 8.0 mm...216	
16 G-19725 KATZIN KERATOPLASTY SCISSORS left, 10 cm.....	81	33 G-560850 NANOEDGE VACUUM CORNEAL PUNCH 8.5 mm...216	
17 G-19765 VANNAS CAPSULOTOMY SCISSORS curved.....	84		

DSEK / DSAEK - DESCEMET'S STRIPPING (AUTOMATED) ENDOTHELIAL KERATOPLASTY

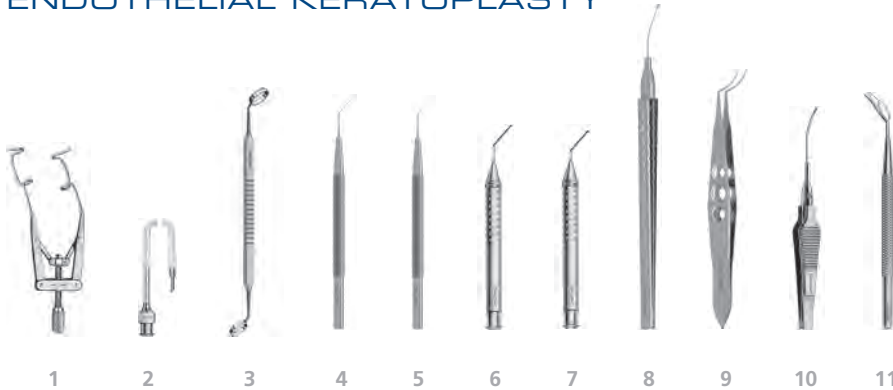

	page		page
1 G-15960 <i>LIEBERMANN-TENNANT EYE SPECULUM</i>	25	7 G-38602 <i>NEUHANN IRRIGATION DESCEMET SCRAPER</i>	202
2 G-33416 <i>BOPP A.C. INFUSION CANNULA</i> silicone tube.....	191	8 G-38634 <i>GERTEN DSAEK/DMEK RHEXIS FORCEPS</i> 23G.....	117
3 G-38600 <i>NEUHANN CORNEAL MARKER</i> double 8 / 9 mm.....	41	9 G-38603 <i>DSA EK IMPLANTATION FORCEPS</i>	118
4 G-38607 <i>DESCEMET INCISION HOOK</i> 0.2 mm tip.....	168	10 G-38606 <i>TH. NEUHANN DSAEK FORCEPS</i> 21G.....	118
5 G-38608 <i>DESCEMET SCRAPER</i>	168	11 G-38604 <i>TH. NEUHANN DSAEK INSERTION SPATULA</i>	168
6 G-38601 <i>ALTHAUSCARTSBURG IRRIGATION DESCEMET HOOK</i>	202		

DALK - DEEP ANTERIOR LAMELLAR KERATOPLASTY

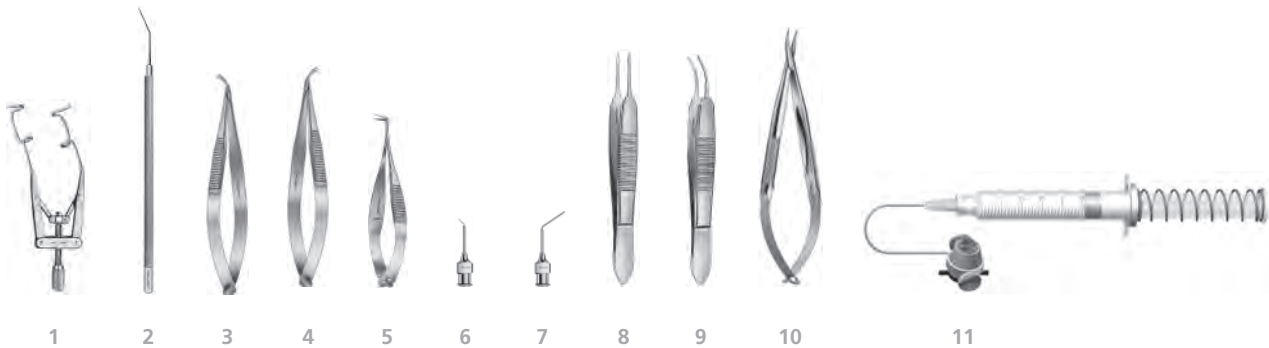

	page		page
1 G-15960 <i>LIEBERMANN-TENNANT EYE SPECULUM</i>	25	7 G-15312 <i>KRUMEICH CORNEAL IRRIGATION CANNULA</i> 23G..	197
2 G-32728 <i>RENTSCH SPATULA</i> tapered 0.6 to 0.3 mm.....	159	8 G-19030 <i>TUEBINGEN TYING FORCEPS</i> straight.....	106
3 G-19720 <i>KATZIN KERATOPLASTY SCISSORS</i> right, 10 cm.....	81	9 G-19040 <i>TUEBINGEN TYING FORCEPS</i> curved.....	106
4 G-19725 <i>KATZIN KERATOPLASTY SCISSORS</i> left, 10 cm.....	81	10 G-17505 <i>BARRAQUER NEEDLE HOLDER</i> curved, w/o lock.....	139
5 G-19770 <i>VANNAS CAPSULOTOMY SCISSORS</i> angled to side.....	84	11 G-570800 <i>NANOEDGE VACUUM TREPHINE</i> 8.0 mm.....	216
6 G-15310 <i>KRUMEICH CORNEAL IRRIGATION CANNULA</i> 27G..	197		

DSEK / DSAEK · DALK

DMEK - DESCemet MEMBRANE ENDOTHELIAL KERATOPLASTY

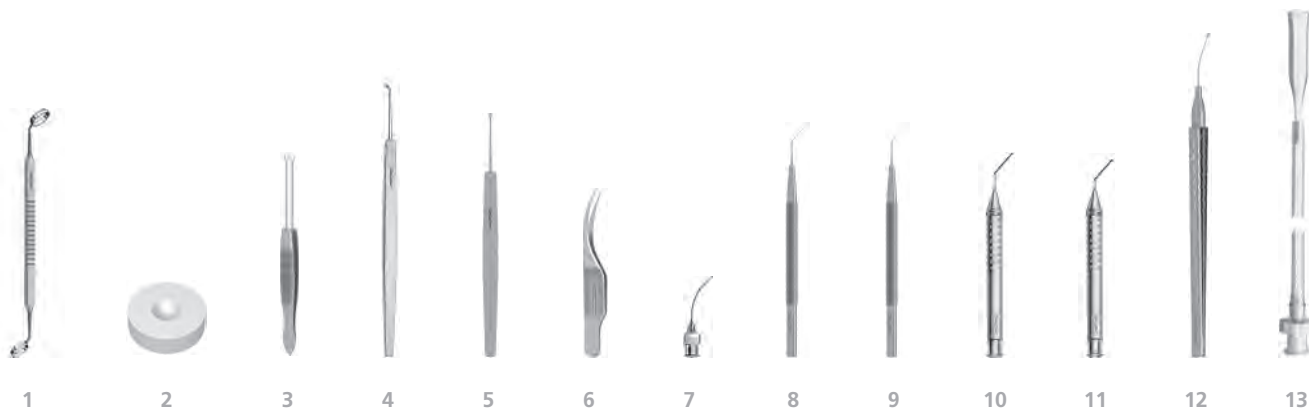

	page		page
1 G-38600 NEUHANN CORNEAL MARKER double 8 / 9 mm.....	41	8 G-38607 DESCemet INCISION HOOK 0.2 mm tip.....	168
2 G-38620 SZURMAN DMEK GRAFT RETAINER.....	71	9 G-38608 DESCemet SCRAPER.....	168
3 G-38623 REMKY DMEK KERATOPLASTY FORCEPS.....	105	10 G-38601 ALTHAUS-CARTSBURG IRRIGATION DESCemet HOOK.....	202
4 G-38621 SZURMAN DMEK PREPARATION SCRAPER.....	64	11 G-38602 NEUHANN IRRIGATION DESCemet SCRAPER.....	202
5 G-38622 SZURMAN DMEK PREPARATION SPATULA.....	168	12 G-38634 GERTEN DSAEK/DMEK RHEXIS FORCEPS 23G.....	117
6 G-38624 SZURMAN DMEK PREPARATION FORCEPS.....	117	13 G-38635 SZURMAN SINGLE-USE DMEK CARTRIDGE 1.6 mm.....	223
7 G-32167 SAUTTER HYDRODIS. CANNULA 27G, horiz flat.....	192		

GLAUCOMA

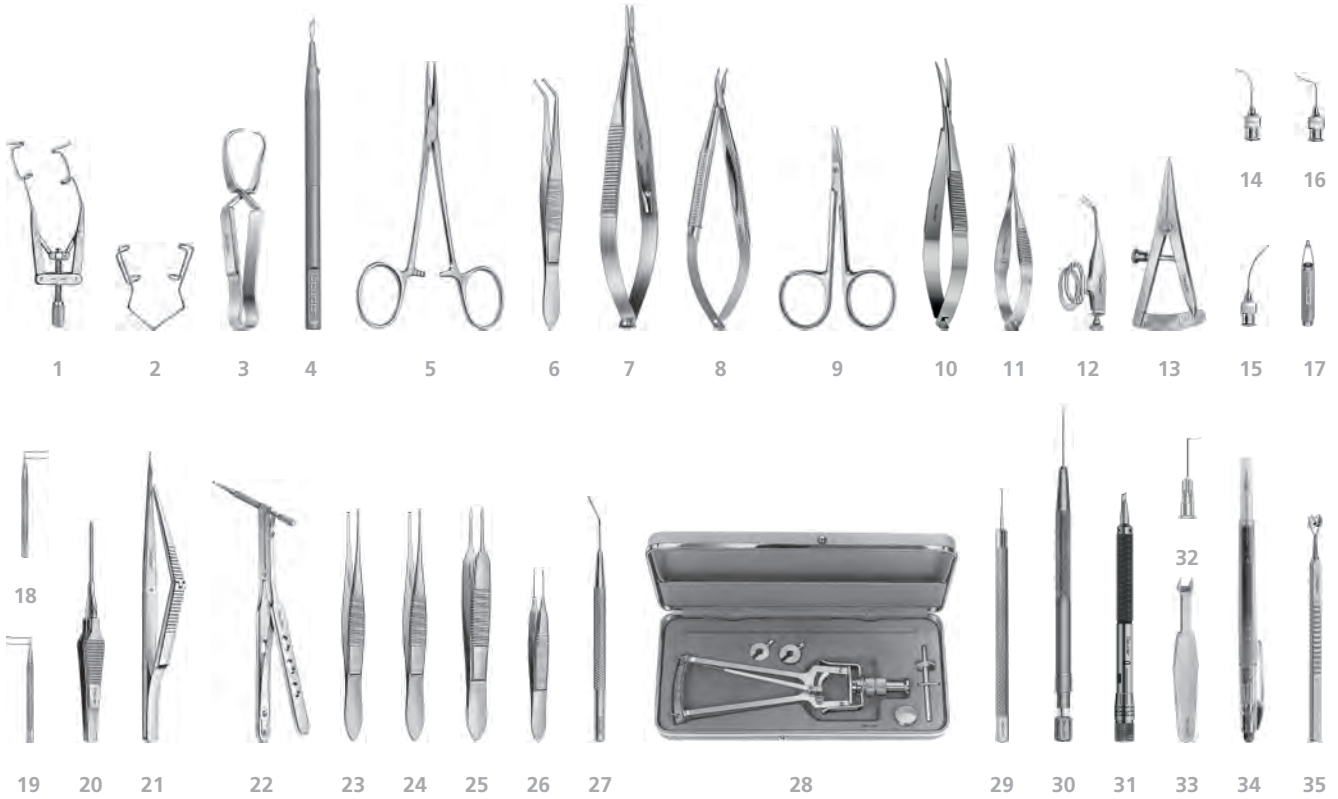

	page		page
1 G-15960 <i>LIEBERMANN-TENNANT EYE SPECULUM</i>	25	20 G-18235 <i>GREHN GLAUCOMA PUNCH 20G</i>	76
2 G-17020 <i>BARRAQUER EYE SPECULUM</i> fenestrated.....	15	21 G-18238 <i>KELLY DESCEMET PUNCH</i> for Glaucoma, 1.0 mm.....	76
3 G-33200 <i>SCHAEDEL TOWEL FORCEPS</i>	136	22 G-18239 <i>LUNTZ-DODICK TRABECULECTOMY PUNCH</i> 360° rotatable.....	76
4 G-34036 <i>NANOEDGE PARACENTESIS KNIFE 30°</i> straight.....	217	23 G-18791 <i>DRESSING FORCEPS</i> 1 x 2 teeth, 0.7 mm.....	110
5 G-18180 <i>HALSTEAD MOSQUITO FORCEPS</i> straight.....	135	24 G-18792 <i>DRESSING FORCEPS</i> 1 x 2 teeth, 1.0 mm.....	110
6 G-18820 <i>REMKY SUPERIOR RECTUS FORCEPS</i>	125	25 G-19030 <i>TUEBINGEN TYING FORCEPS</i> straight.....	106
7 G-17565 <i>CASTROVIEJO NEEDLE HOLDER</i> straight, w. lock.....	142	26 G-18900 <i>BONN IRIS FORCEPS</i> straight, 1 x 2 teeth.....	110
8 G-17500 <i>BARRAQUER NEEDLE HOLDER</i> curved, w/o lock.....	139	27 G-16190 <i>SPATULA</i> angled, 1.0 mm wide.....	159
9 G-19400 <i>BONN EYE SCISSORS</i> curved, delicate.....	92	28 G-19230 <i>SCHIOETZ TONOMETER</i>	48
10 G-19750 <i>WESTCOTT SCISSORS</i> blunt tips, curved, 12 cm.....	89	29 G-14105 <i>MICRO ROUND KNIFE</i> for viscocanalostomy.....	63
11 G-19630 <i>TUEBINGEN CAPSULOTOMY SCISSORS</i> curved.....	84	30 G-31487 <i>DIAMOND KNIFE</i> for viscocanalostomy.....	62
12 G-19680 <i>BARRAQUER SCISSORS</i> 7 mm blades.....	87	31 G-31470 <i>TRI-FACET DIAMOND STEP KNIFE</i>	61
13 G-19130 <i>CASTROVIEJO CALIPER</i> 15 mm.....	43	32 G-15197 <i>SINGLE-USE IRRIGATION CANNULA</i> angled, 35G.....	226
14 G-15185 <i>FRANKFURT HYDRODISSECTION CANNULA</i> 27G.....	192	33 G-32210 <i>FRONIMOPOULUS MARKER</i> U-shaped.....	44
15 G-15250 <i>SAUTTER HYDRODIS. CANNULA</i> 27G, vert flat.....	192	34 G-33786 <i>MARKING PEN</i> gentian violet, 20 pcs./box.....	231
16 G-22619 <i>PH. JACOBI TRABECULAR ASPIRATION CANNULA</i>	193	35 G-32209 <i>TOBIAS NEUHANN SCLERAL FLAP MARKER</i>	44
17 G-20612 <i>SCHMIDT-MUMM DUCT TREPHINE</i> 1.2 mm.....	69	36 G-39526 <i>STERISAFE DURO A4 PLUS COMPLETE SET</i>	259
18 G-15125 <i>HARMS TRABECULAR PROBE</i> right.....	186		
19 G-15130 <i>HARMS TRABECULAR PROBE</i> left.....	186		

GLAUCOMA

EMERGENCY

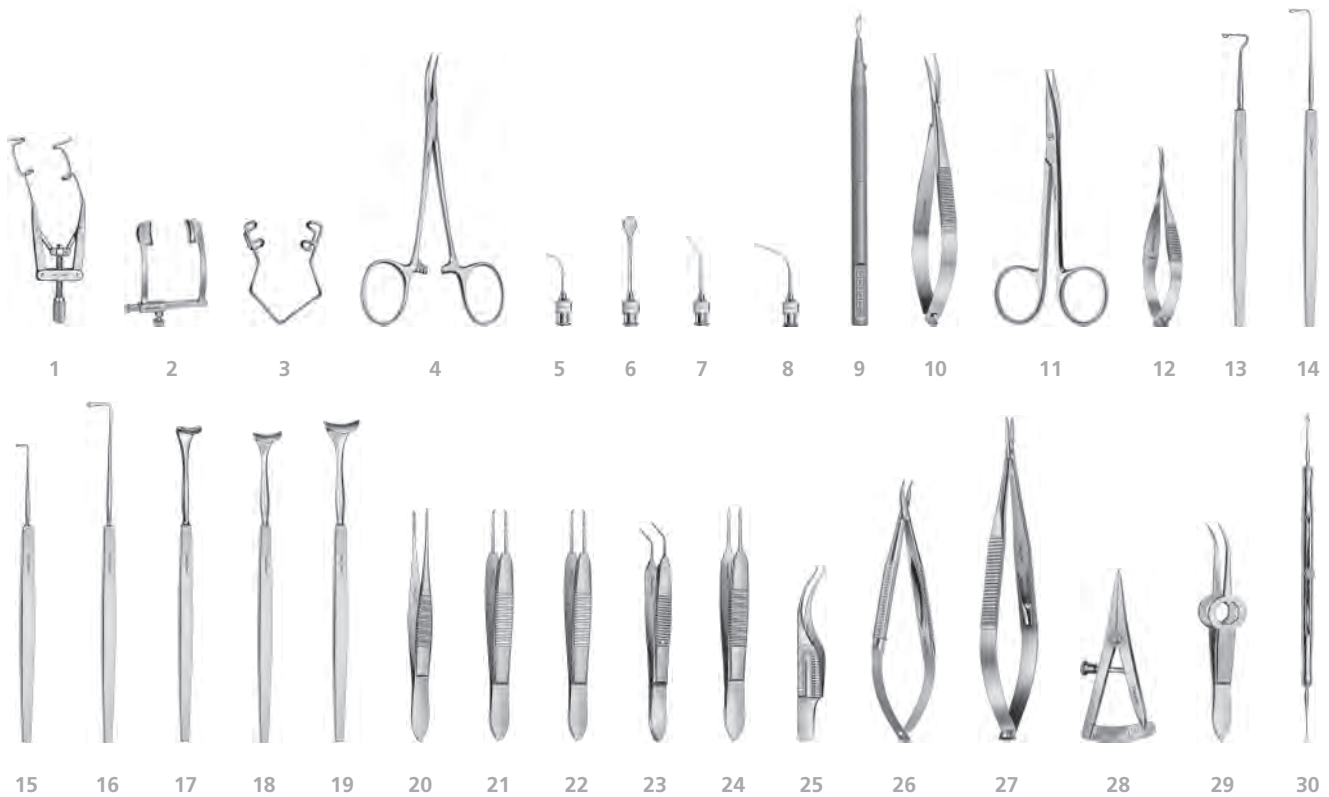

	page		page
1	25	17	35
2	23	18	35
3	15	19	35
4	135	20	110
5	192	21	103
6	191	22	103
7	189	23	107
8	189	24	106
9	217	25	104
10	89	26	139
11	89	27	142
12	84	28	43
13	174	29	101
14	173	30	55
15	173		
16	174		

ENUCLEATION

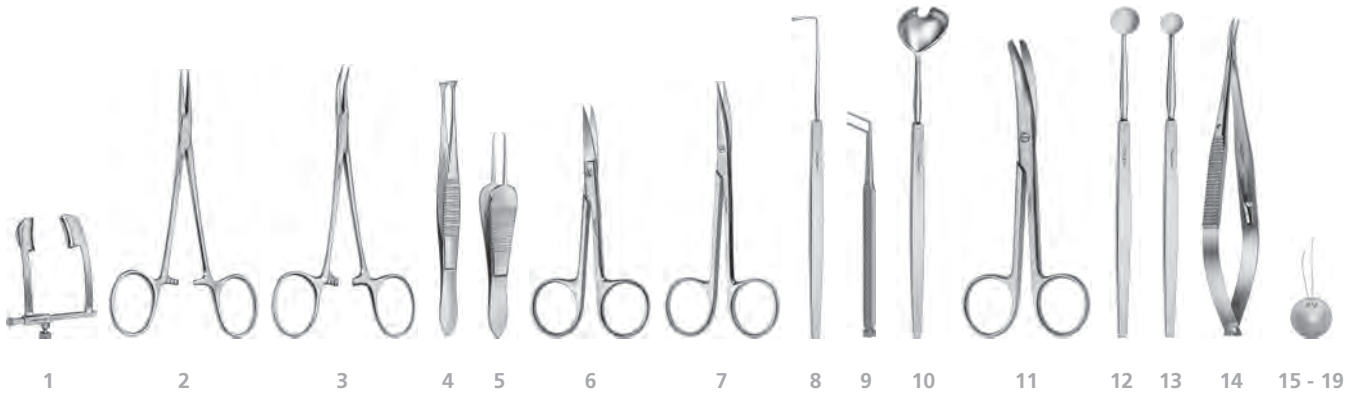

	page		page
1 G-15990 COOK EYE SPECULUM large.....	23	11 G-19525 ENUCLEATION SCISSORS medium curve, 13.5 cm.....	94
2 G-18180 HALSTEAD MOSQUITO FORCEPS straight.....	135	12 G-31545 BUNGE EXENTERATION CURETTE medium.....	52
3 G-18181 HALSTEAD MOSQUITO FORCEPS curved.....	135	13 G-31555 BUNGE EXENTERATION CURETTE large.....	52
4 G-19050 GRAEFE FIXATION FORCEPS without lock.....	109	14 G-17575 CASTROVIEJO NEEDLE HOLDER curved, w. lock.....	142
5 G-18940 PAUFIQUE UNIVERSAL SUTURING FORCEPS.....	105	15 G-20416 WALSER EYE SPHERE 16 mm.....	245
6 G-19375 EYE SCISSORS curved, sharp tips, 10 cm.....	91	16 G-20417 WALSER EYE SPHERE 17 mm.....	245
7 G-19485 STEVENS TENOTOMY SCISSORS curved, long.....	89	17 G-20418 WALSER EYE SPHERE 18 mm.....	245
8 G-15810 GRAEFE STRABISMUS HOOK large, 12 mm.....	173	18 G-20419 WALSER EYE SPHERE 19 mm.....	245
9 G-19112 BANGERTER MUSCLE FORCEPS.....	126	19 G-20420 WALSER EYE SPHERE 20 mm.....	245
10 G-15780 WELLS ENUCLEATION SPOON.....	167	20 G-39526 STERISAFE DURO A4 PLUS COMPLETE SET.....	259

PTERYGIUM

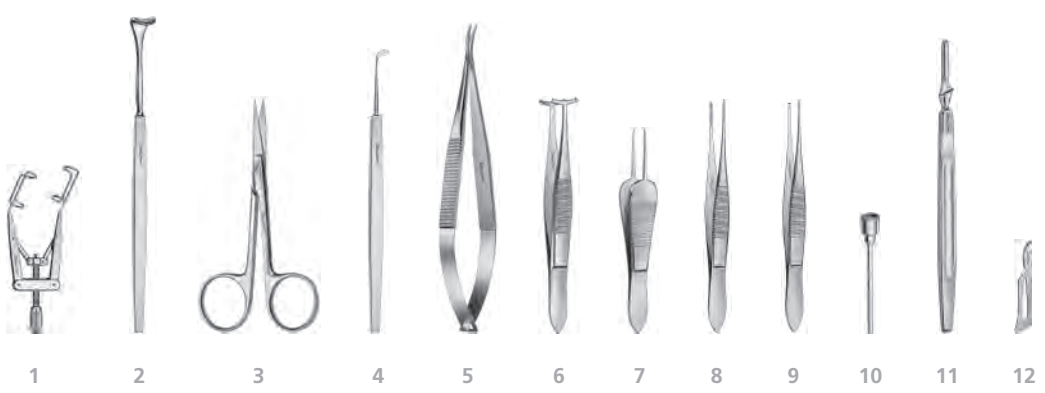

	page		page
1 G-15965 KERSHNER EYE SPECULUM fenestrated.....	25	7 G-18940 PAUFIQUE UNIVERSAL SUTURING FORCEPS.....	105
2 G-32120 DESMARRES LID RETRACTOR fig. 0.....	35	8 G-18782 DRESSING FORCEPS serrated, 1.0 mm.....	110
3 G-19355 EYE SCISSORS straight, sharp tips, 10 cm.....	91	9 G-18792 DRESSING FORCEPS 1 x 2 teeth, 1.0 mm.....	110
4 G-14010 KUHN CORNEAL SCARIFIER fig. 1.....	64	10 G-18300 DIAMOND BURR 8.0 mm.....	244
5 G-17570 CASTROVIEJO NEEDLE HOLDER curved, w/o lock.....	142	11 G-32700 SCALPEL HANDLE.....	231
6 G-19080 BARRAQUER FIXATION FORCEPS.....	109	12 G-32705 SCALPEL SURGICAL BLADES #11, curved, 100 pcs.....	231

ENUCLEATION · PTERYGIUM

OFFICE SET (OPTOMETRIST)



	page		page
1 G-17020 <i>BARRAQUER EYE SPECULUM</i> fenestrated.....	15	10 G-19460 <i>STRABISMUS SCISSORS</i> short, straight.....	91
2 G-17025 <i>BARRAQUER EYE SPECULUM</i> infants, fenestrated.....	15	11 G-32715 <i>SCHOCKET SCLERAL DEPRESSOR</i>	180
3 G-18975 <i>BARRAQUER SUTURE REMOVING FORCEPS</i>	104	12 G-15870 <i>MEYHOEFFER CHALAZION CURETTE</i> 2 mm.....	51
4 G-19765 <i>VANNAS CAPSULOTOMY SCISSORS</i> curved.....	84	13 G-18680 <i>LAMBERT CHALAZION FORCEPS</i>	134
5 G-18750 <i>BARRAQUER CILIA FORCEPS</i>	101	14 G-31105 <i>EYE SHIELD</i> plastic, transparent, 100 pcs.....	245
6 G-14550 <i>FOREIGN BODY INSTRUMENT</i> needle/spud.....	55	15 G-15230 <i>BONN IRRIGATION CANNULA</i> delicate.....	194
7 G-18850 <i>SHAAF CILIA AND FOREIGN BODY FORCEPS</i>	101	16 G-32665 <i>SILICONE BULB</i> 20 ml.....	212
8 G-150401 <i>WILDER LACRIMAL PROBE</i> slim, long taper.....	183	17 G-32920 <i>JAMESON STRABISMUS HOOK</i> 11 mm.....	174
9 G-32120 <i>DESMARRES LID RETRACTOR</i> fig. 0.....	35	18 G-39526 <i>STERISAFE DURO A4 PLUS COMPLETE SET</i>	259

CHALAZION

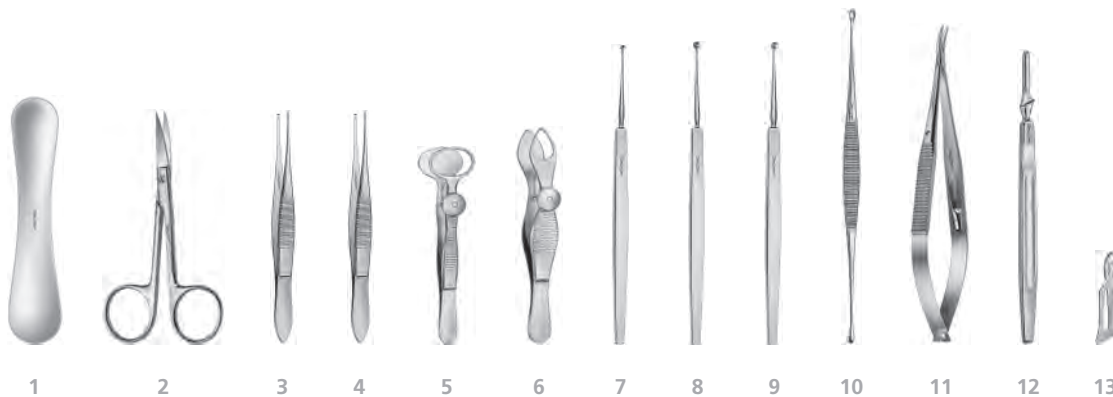

	page		page
1 G-17040 <i>JAEGER LID PLATE</i> stainless steel.....	36	8 G-15875 <i>MEYHOEFFER CHALAZION CURETTE</i> 2.5 mm.....	51
2 G-19375 <i>EYE SCISSORS</i> curved, sharp tips, 10 cm.....	91	9 G-15880 <i>MEYHOEFFER CHALAZION CURETTE</i> 3.0 mm.....	51
3 G-18791 <i>DRESSING FORCEPS</i> 1 x 2 teeth, 0.7 mm.....	110	10 G-15910 <i>AXENFELD CHALAZION CURETTE</i>	52
4 G-18792 <i>DRESSING FORCEPS</i> 1 x 2 teeth, 1.0 mm.....	110	11 G-17575 <i>CASTROVIEJO NEEDLE HOLDER</i> curved, w. lock.....	142
5 G-18685 <i>DESMARRES CHALAZION FORCEPS</i> 20 mm.....	134	12 G-32700 <i>SCALPEL HANDLE</i>	231
6 G-18710 <i>LORDAN CHALAZION FORCEPS</i> triangular.....	134	13 G-32705 <i>SCALPEL SURGICAL BLADES</i> #11, curved, 100 pcs..	231
7 G-15870 <i>MEYHOEFFER CHALAZION CURETTE</i> 2.0 mm.....	51		

LID / PTOSIS

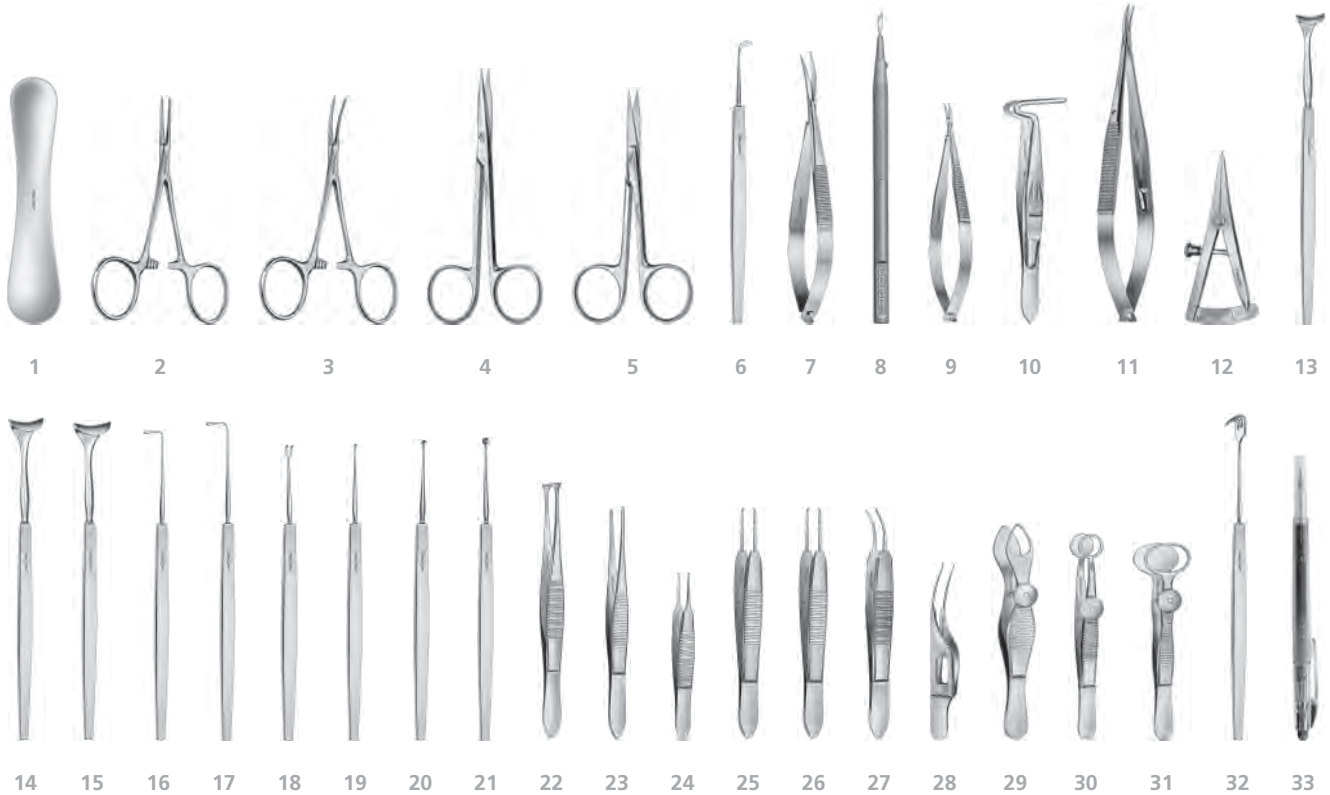

	page		page
1	36	18	36
2	135	19	51
3	135	20	51
4	89	21	51
5	91	22	109
6	64	23	102
7	89	24	111
8	217	25	103
9	82	26	103
10	134	27	106
11	142	28	104
12	43	29	134
13	35	30	134
14	35	31	134
15	36	32	37
16	173	33	231
17	173		

LID / PTOSIS

DCR / LACRIMAL

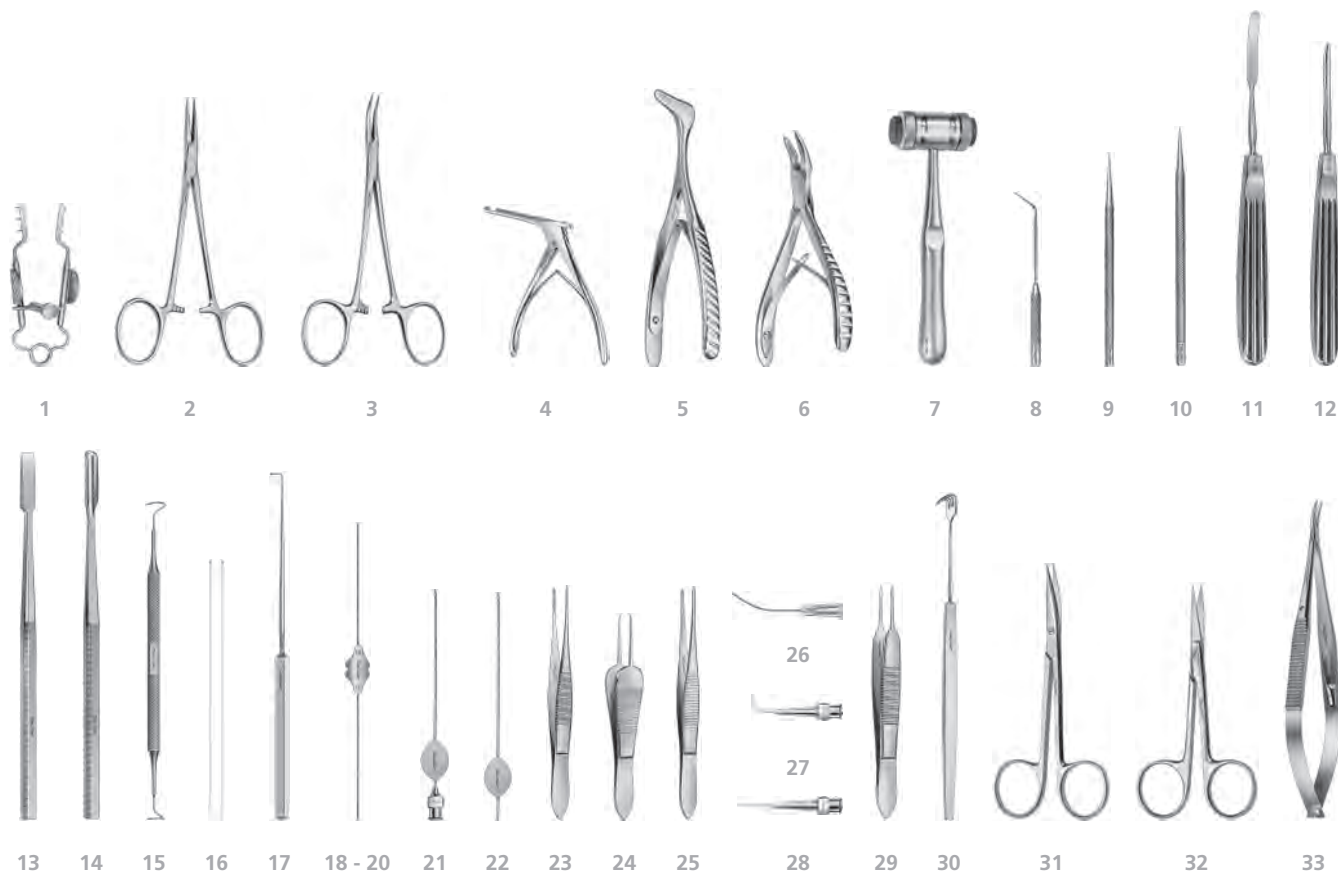

	page		page
1 G-17070 <i>MUELLER LACRIMAL SAC RETRACTOR</i>	38	18 G-150101 <i>BOWMAN LACRIMAL PROBE</i> size 0000/000.....	185
2 G-18180 <i>HALSTEAD MOSQUITO FORCEPS</i> straight.....	135	19 G-150102 <i>BOWMAN LACRIMAL PROBE</i> size 00/0.....	185
3 G-18181 <i>HALSTEAD MOSQUITO FORCEPS</i> curved.....	135	20 G-150103 <i>BOWMAN LACRIMAL PROBE</i> size 1/2.....	185
4 G-18225 <i>KERRISON BONE NIBBLING RONGEUR</i>	75	21 G-33198 <i>JUENEMANN LACRIMAL PROBE CANNULA</i>	190
5 G-32355 <i>NASAL SPECULUM</i>	242	22 G-33194 <i>JUENEMANN LACRIMAL PROBE</i> 0.8 mm, w grip plate.....	186
6 G-31810 <i>FRIEDMANN RONGEUR</i>	242	23 G-18782 <i>DRESSING FORCEPS</i> serrated, 1.0 mm.....	110
7 G-33125 <i>MEAD HAMMER</i> length 19 cm, 300 g.....	242	24 G-18940 <i>PAUFIQUE UNIVERSAL SUTURING FORCEPS</i>	105
8 G-15020 <i>GIESSEN LACRIMAL PROBE</i> angled.....	183	25 G-18810 <i>DRAEGER CONJUNCTIVA FORCEPS</i> atraumatic.....	102
9 G-150401 <i>WILDER LACRIMAL PROBE</i> slim, long taper.....	183	26 G-34290 <i>SINGLE-USE LACRIMAL CANNULA</i> curved, 26G.....	224
10 G-150302 <i>WILDER LACRIMAL PROBE</i> medium.....	183	27 G-15190 <i>ANEL LACRIMAL CANNULA</i> straight, 23G.....	189
11 G-18620 <i>HEIDELBERG RASPATORY</i>	242	28 G-15195 <i>ANEL LACRIMAL CANNULA</i> round curve, 23G.....	189
12 G-18630 <i>HEIDELBERG ELEVATORIUM</i>	242	29 G-19030 <i>TUEBINGEN TYING FORCEPS</i> straight.....	106
13 G-18240 <i>BONE CHISEL</i> flat, 5.0 mm wide.....	243	30 G-15542 <i>AXENFELD LACRIMAL SAC RETRACTOR</i>	37
14 G-18245 <i>BONE CHISEL</i> hollow, 5.0 mm wide.....	243	31 G-19485 <i>STEVENS TENOTOMY SCISSORS</i> curved, long.....	89
15 G-15095 <i>PIGTAIL PROBE</i> with suture holes.....	184	32 G-19355 <i>EYE SCISSORS</i> straight, sharp tips, 10 cm.....	91
16 G-34812 <i>LACRIMAL INTUBATION SET</i> olive tips, 27G.....	224	33 G-17575 <i>CASTROVIEJO NEEDLE HOLDER</i> curved, w. lock.....	142
17 G-32726 <i>MUENSTER SUTURE HOOK</i>	172		

STRABISMUS / MUSCLE

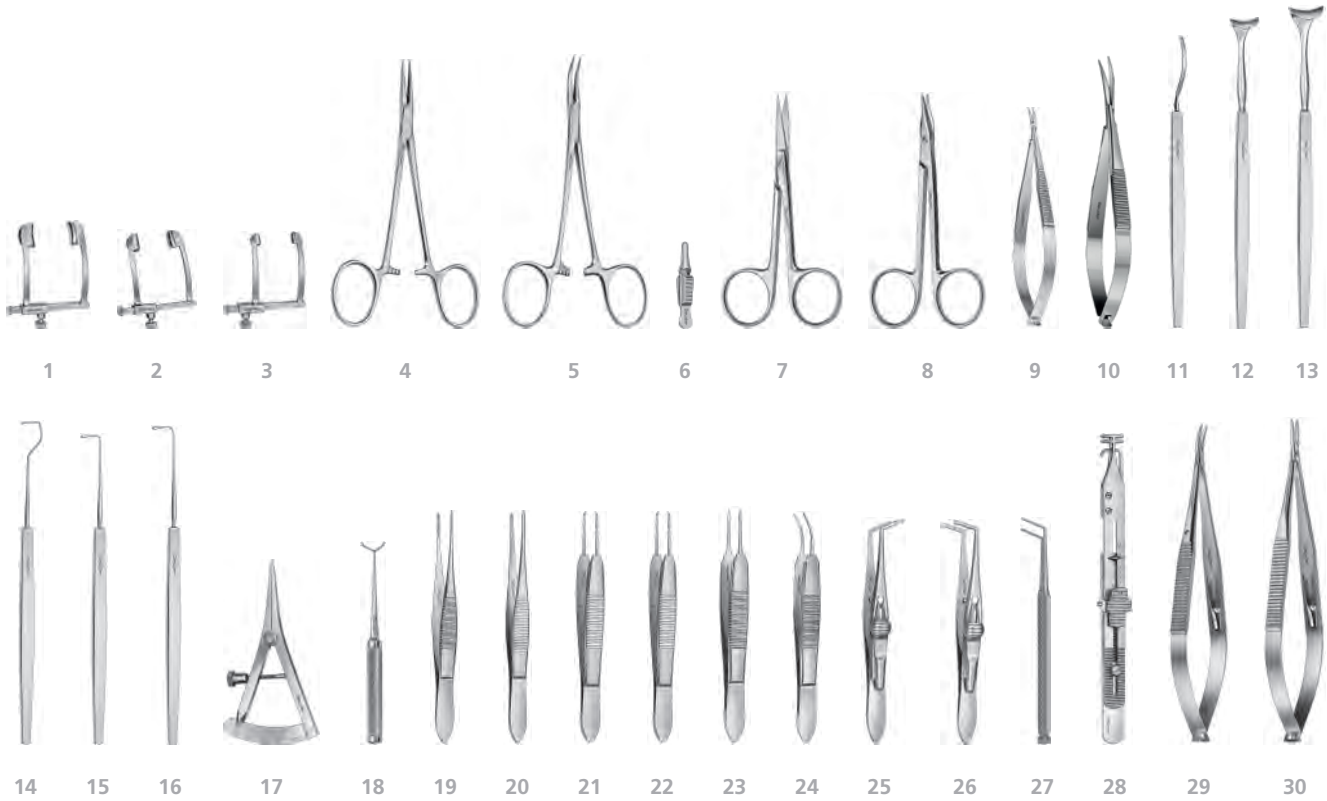

	page		page
1 G-15995 COOK EYE SPECULUM medium, 11 mm.....	23	16 G-15805 GRAEFE STRABISMUS HOOK medium, 10 mm.....	173
2 G-16000 COOK EYE SPECULUM small, 8 mm.....	24	17 G-19135 CASTROVIEJO CALIPER 20 mm.....	43
3 G-32128 COOK EYE SPECULUM infants, 5 mm.....	24	18 G-15797 FINK MARKER for 9 mm recession.....	44
4 G-18180 HALSTEAD MOSQUITO FORCEPS straight.....	135	19 G-18782 DRESSING FORCEPS serrated, 1.0 mm.....	110
5 G-18181 HALSTEAD MOSQUITO FORCEPS curved.....	135	20 G-18810 DRAEGER CONJUNCTIVA FORCEPS atraumatic.....	102
6 G-18190 DIEFFENBACH SERREFINE straight, 35 mm.....	136	21 G-19010 CASTROVIEJO SUTURING FORCEPS 0.6 mm.....	103
7 G-19355 EYE SCISSORS straight, sharp tips, 10 cm.....	91	22 G-19005 CASTROVIEJO SUTURING FORCEPS 0.3 mm.....	103
8 G-19475 STEVENS TENOTOMY SCISSORS curved, short.....	89	23 G-19030 TUEBINGEN TYING FORCEPS straight.....	106
9 G-19600 CORNEAL SCISSORS light curve, sharp tips.....	82	24 G-19040 TUEBINGEN TYING FORCEPS curved.....	106
10 G-19750 WESTCOTT SCISSORS blunt tips, curved, 12 cm.....	89	25 G-19120 SATTLER MUSCLE FORCEPS w. slide lock, right.....	127
11 G-32225 VOGT SCLERAL RULER.....	44	26 G-19125 SATTLER MUSCLE FORCEPS w. slide lock, left.....	127
12 G-16060 DESMARRES LID RETRACTOR fig. 1.....	35	27 G-19112 BANGERTER MUSCLE FORCEPS.....	126
13 G-16065 DESMARRES LID RETRACTOR fig. 2.....	35	28 G-19137 CUEPPERS STRABISMUS MUSCLE TUCKER.....	42
14 G-15830 MALBRAN STRABISMUS HOOK.....	174	29 G-17575 CASTROVIEJO NEEDLE HOLDER curved, w. lock.....	142
15 G-15800 GRAEFE STRABISMUS HOOK small, 8 mm.....	173	30 G-17565 CASTROVIEJO NEEDLE HOLDER straight, w. lock.....	142

RETINAL DETACHMENT

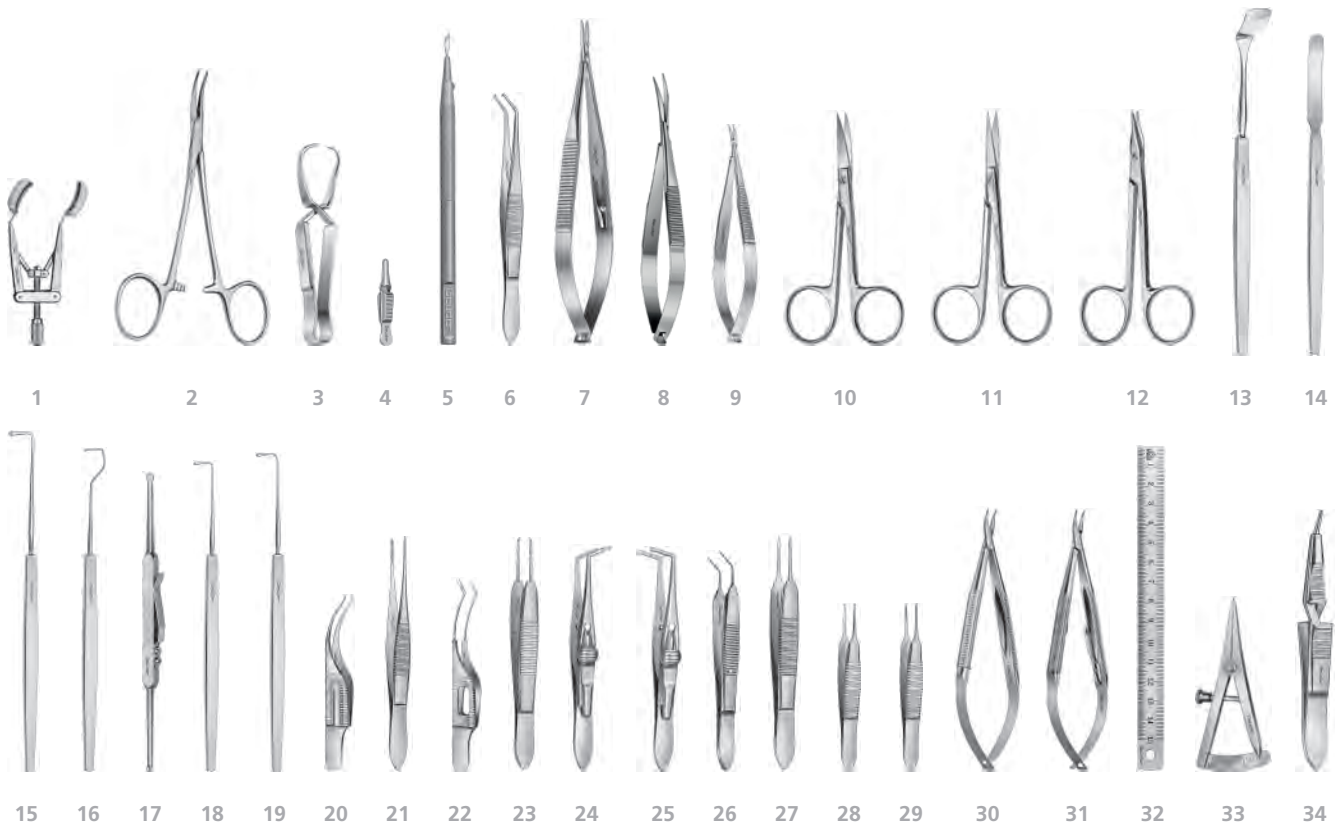

	page		page
1 G-15966 <i>KERSHNER EYE SPECULUM</i> solid blades.....	25	18 G-15800 <i>GRAEFE STRABISMUS HOOK</i> small, 8 mm.....	173
2 G-18182 <i>HALSTEAD MOSQUITO FORCEPS</i> curved, 1x2 teeth.....	135	19 G-15805 <i>GRAEFE STRABISMUS HOOK</i> medium, 10 mm.....	173
3 G-33200 <i>SCHAEDEL TOWEL FORCEPS</i>	136	20 G-18950 <i>COLIBRI FORCEPS</i> with tying platform.....	104
4 G-18190 <i>DIEFFENBACH SERREFINE</i> straight, 35 mm.....	136	21 G-18782 <i>DRESSING FORCEPS</i> serrated, 1.0 mm.....	110
5 G-34026 <i>NANOEDGE PARACENTESIS KNIFE 15°</i> straight.....	217	22 G-18792 <i>DRESSING FORCEPS</i> 1 x 2 teeth, 1.0 mm.....	110
6 G-18820 <i>REMKY SUPERIOR RECTUS FORCEPS</i>	125	23 G-19005 <i>CASTROVIEJO SUTURING FORCEPS</i> 0.3 mm.....	103
7 G-17565 <i>CASTROVIEJO NEEDLE HOLDER</i> straight, w. lock.....	142	24 G-19120 <i>SATTLER MUSCLE FORCEPS</i> w slide lock, right.....	127
8 G-19750 <i>WESTCOTT SCISSORS</i> blunt tips, curved, 12 cm.....	89	25 G-19125 <i>SATTLER MUSCLE FORCEPS</i> w slide lock, left.....	127
9 G-19600 <i>CORNEAL SCISSORS</i> light curve, sharp tips.....	82	26 G-19032 <i>TYING FORCEPS</i> angled, 7.5 mm.....	107
10 G-19375 <i>EYE SCISSORS</i> curved, sharp tips, 10 cm.....	91	27 G-19030 <i>TUEBINGEN TYING FORCEPS</i> straight.....	106
11 G-19355 <i>EYE SCISSORS</i> straight, sharp tips, 10 cm.....	91	28 G-31953 <i>IRIS FORCEPS</i> straight, 1 x 2 teeth, strong.....	111
12 G-19475 <i>STEVENS TENOTOMY SCISSORS</i> curved, short.....	89	29 G-18855 <i>IRIS FORCEPS</i> straight, serrated.....	110
13 G-32445 <i>HAMBURG ORBITAL SPATULA</i> 18 x 12 mm.....	162	30 G-17500 <i>BARRAQUER NEEDLE HOLDER</i> curved, w/o lock.....	139
14 G-15720 <i>BANGERTER SPATULA</i> 6 mm wide.....	162	31 G-17501 <i>BARRAQUER NEEDLE HOLDER</i> curved, w. lock.....	139
15 G-15821 <i>BONN STRABISMUS HOOK</i> 1.0 mm hole.....	174	32 G-18650 <i>RULER</i> 150 mm, 0.5 mm increments.....	43
16 G-15830 <i>MALBRAN STRABISMUS HOOK</i>	174	33 G-19130 <i>CASTROVIEJO CALIPER</i> 15 mm.....	43
17 G-32150 <i>LAQUA SCLERAL DEPRESSOR</i> double-ended.....	179	34 G-33752 <i>WATZKE SPREADING FORCEPS</i>	127

VITRECTOMY 20G

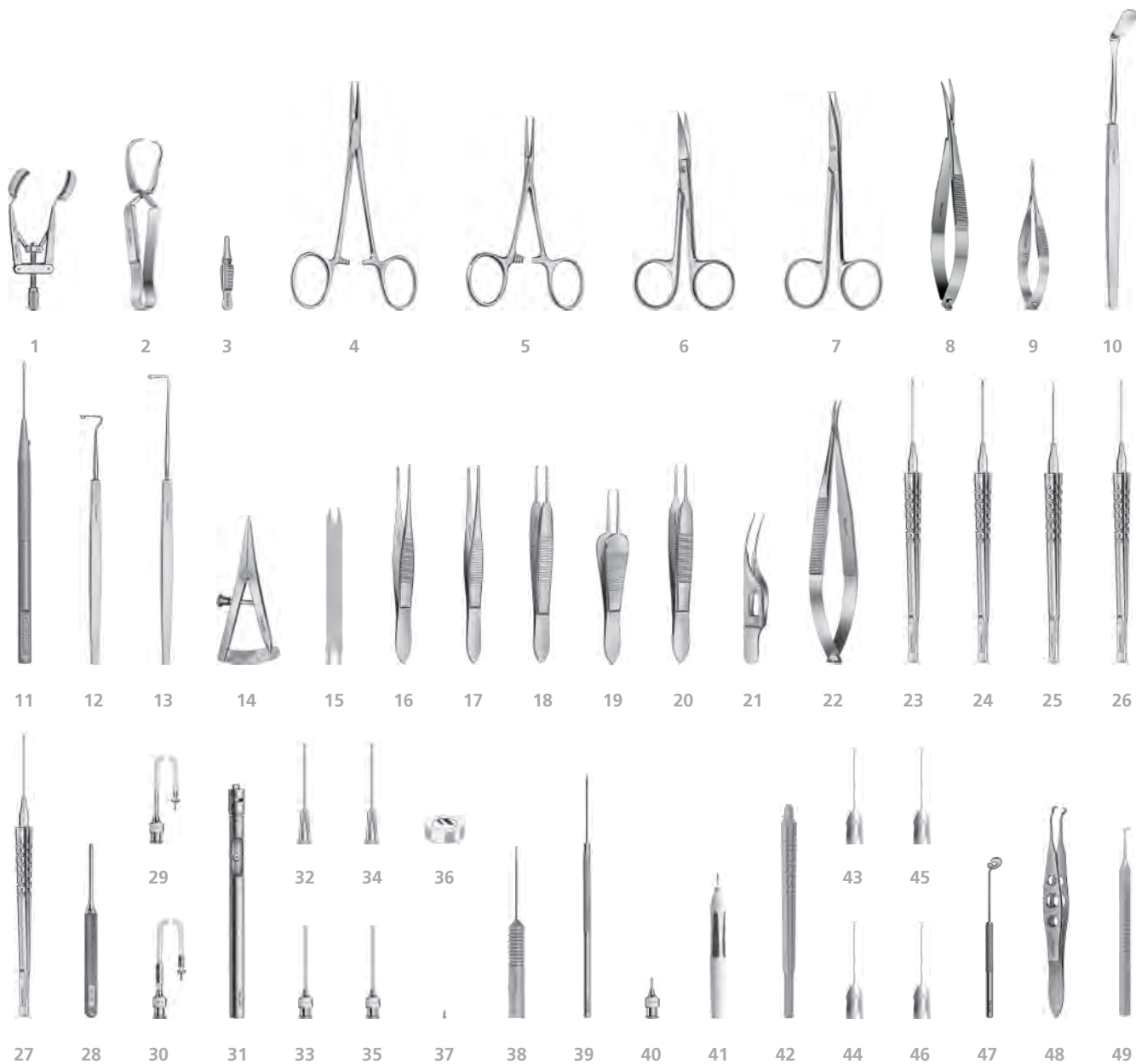

VITRECTOMY 20G

	page		page
1	25	29	209
2	136	30	209
3	136	31	206
4	135	32	227
5	135	33	207
6	91	34	227
7	89	35	207
8	89	36	244
9	84	37	128
10	163	38	175
11	217	39	175
12	174	40	210
13	174	41	221
14	43	42	218
15	43	43	219
16	110	44	218
17	102	45	219
18	103	46	219
19	105	47	150
20	106	48	129
21	104	49	175
22	142	50	249
23	130	51	249
24	130	52	250
25	130	53	249
26	95		
27	95		
28	246		

VITRECTOMY 23G

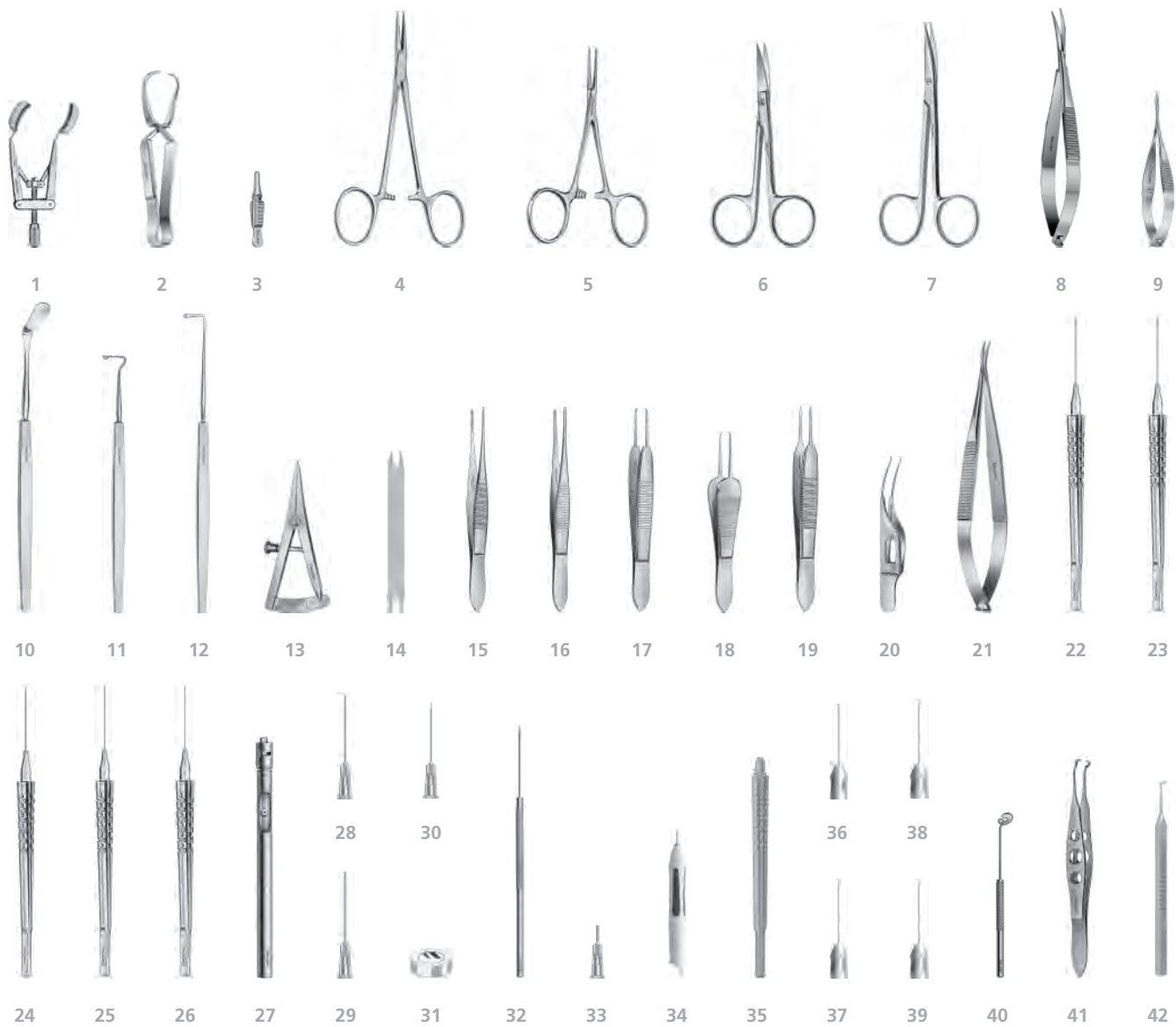

VITRECTOMY 23G

	page		page
1	25	26	96
2	136	G-36540	HEIMANN VITREORETINAL SCISSORS 23G, angled, for trocars.....
3	136	27	206
4	135	G-37002	BACKFLUSH HANDPIECE with silicone chamber.....
5	135	28	227
6	91	G-34296	SINGLE-USE BACKFLUSH CANNULA 23G.....
7	89	29	227
8	89	G-34294	SINGLE-USE BACKFLUSH CANNULA 23 G w brush.....
9	84	30	228
10	163	G-34285	SINGLE-USE PFCL CANNULA coaxial, 23G.....
11	174	31	244
12	174	G-36000	KILP LENS 60 D flat, field of vision 20°.....
13	43	32	175
14	43	G-37512	MEMBRANE PEELER 0.4 mm, recessed, angled, 23G.....
15	110	33	228
16	102	G-34498	SINGLE USE CANNULA for silicone oil, 23G.....
17	103	34	221
18	105	G-42311	HATTENBACH / NIKOLIC UNO C TROCAR SYSTEM 23G.....
19	106	35	218
20	104	G-40006	HANDLE UNO C 6 mm, titanium.....
21	142	36	218
22	132	G-42361	UNO C VITREOUS SCISSORS 23G, straight.....
23	132	37	219
24	132	G-46341	UNO C VITREOUS FORCEPS ENDGRIPPING 23G.....
25	96	38	219
		G-46343	UNO C VITREOUS FORCEPS CROCODILE DESIGN 23G.....
		39	219
		G-42344	TANO UNO C FORCEPS 23G.....
		40	150
		G-37425	FIXATION INSTRUMENT for trocar systems.....
		41	129
		G-37430	TROCAR FORCEPS.....
		42	175
		G-37435	HATTENBACH HORSESHOE-HOOK.....
		43	249
		G-39786	MICROSTOP® TRAY MINI low, with lid.....
		44	249
		G-39783	MICROSTOP® TRAY MINI low, without lid.....
		45	250
		G-39782	MICROSTOP® RETAINER ELEMENT low.....
		46	249
		G-39750	MICROSTOP® CONTAINER HIGH for two trays.....

VITRECTOMY 25G

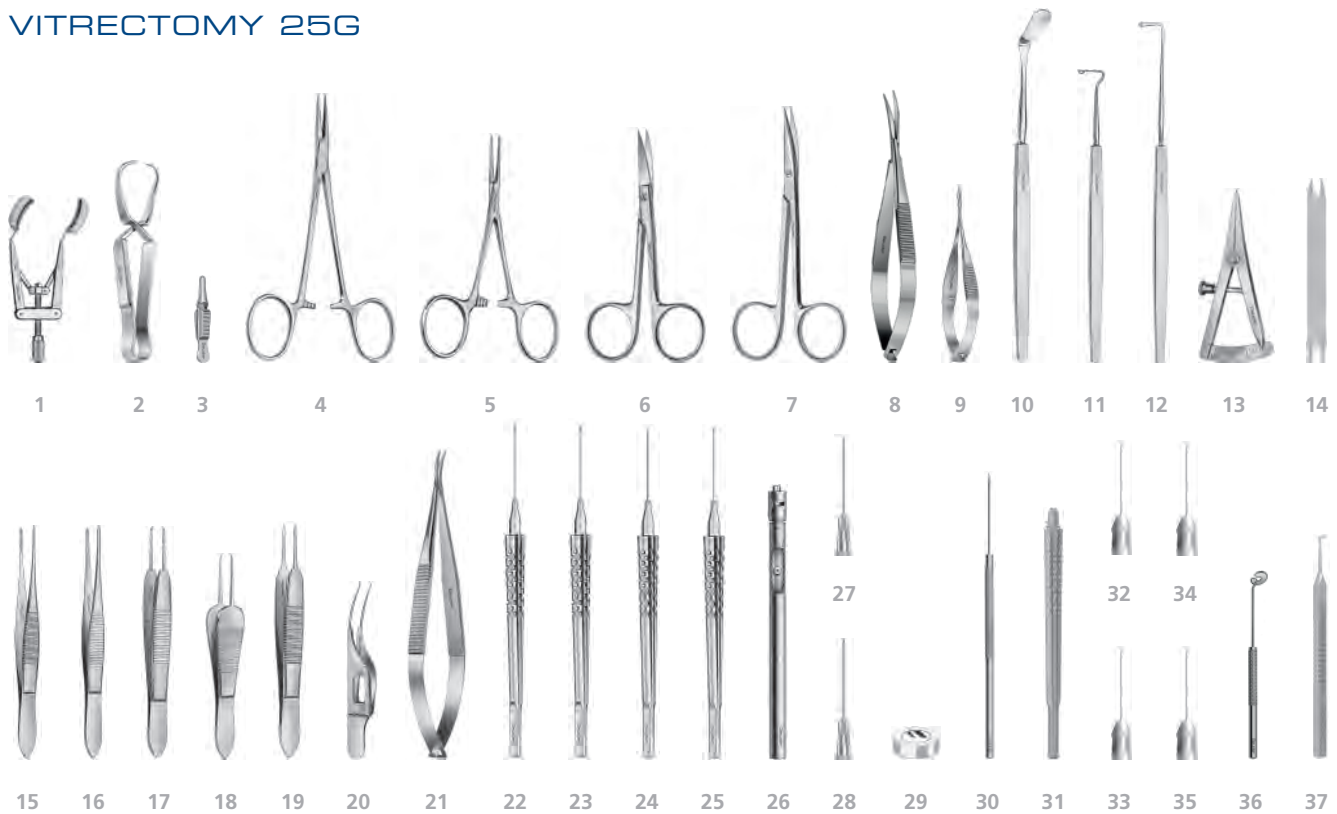

		page			page
1	G-15966 KERSHNER EYE SPECULUM solid blades.....	25	22	G-36312 VITREORETINAL FORCEPS endgripping, 25G.....	132
2	G-33200 SCHAEDEL TOWEL FORCEPS.....	136	23	G-36322 VITREORETINAL FORCEPS crocodile, 25G.....	132
3	G-18190 DIEFFENBACH SERREFINE straight, 35 mm.....	136	24	G-36366 TANO VITREORETINAL FORCEPS serrated, 25G.....	132
4	G-18180 HALSTEAD MOSQUITO FORCEPS straight.....	135	25	G-36586 HEIMANN VITREORETINAL SCISSORS straight, 25G.....	96
5	G-18170 HARTMANN MOSQUITO FORCEPS straight.....	135	26	G-37002 BACKFLUSH HANDPIECE with silicone chamber.....	206
6	G-19375 EYE SCISSORS curved, sharp tips, 10 cm.....	91	27	G-34299 SINGLE-USE BACKFLUSH CANNULA 25G.....	227
7	G-19485 STEVENS TENOTOMY SCISSORS curved, long.....	89	28	G-34297 SINGLE-USE BACKFLUSH CANNULA 25G w brush.....	227
8	G-19750 WESTCOTT SCISSORS blunt tips, curved, 12 cm.....	89	29	G-36000 KILP LENS 60 D flat, field of vision 20°.....	244
9	G-19760 VANNAS CAPSULOTOMY SCISSORS straight.....	84	30	G-37513 MEMBRANE PEELER 0.4 mm, recessed, angled, 25G.....	175
10	G-32446 ORBITAL SPATULA 18 x 8 mm.....	163	31	G-40006 HANDLE UNO C 6 mm, titanium.....	218
11	G-32920 JAMESON STRABISMUS HOOK 11 mm.....	174	32	G-42561 UNO C VITREOUS SCISSORS 25G, straight.....	218
12	G-15821 BONN STRABISMUS HOOK 1.0 mm hole.....	174	33	G-46541 UNO C VITREOUS FORCEPS ENDGRIPPING 25G.....	219
13	G-19130 CASTROVIEJO CALIPER 15 mm.....	43	34	G-46542 HATTENBACH UNO C VITREOUS FORCEPS 25G wave design.....	219
14	G-37410 MARKING INSTRUMENT.....	43	35	G-42544 TANO UNO C FORCEPS 25G.....	219
15	G-18782 DRESSING FORCEPS serrated, 1.0 mm.....	110	36	G-37425 FIXATION INSTRUMENT for trocar systems.....	150
16	G-18810 DRAEGER CONJUNCTIVA FORCEPS atraumatic.....	102	37	G-37435 HATTENBACH HORSESHOE-HOOK.....	175
17	G-19010 CASTROVIEJO SUTURING FORCEPS 0.6 mm.....	103	38	G-39786 MICROSTOP® TRAY MINI low, with lid.....	249
18	G-18940 PAUFIQUE UNIVERSAL SUTURING FORCEPS.....	105	39	G-39783 MICROSTOP® TRAY MINI low, without lid.....	249
19	G-19030 TUEBINGEN TYING FORCEPS straight.....	106	40	G-39782 MICROSTOP® RETAINER ELEMENT low.....	250
20	G-18960 MICRO COLIBRI FORCEPS with tying platform.....	104	41	G-39750 MICROSTOP® CONTAINER HIGH for two trays.....	249
21	G-17570 CASTROVIEJO NEEDLE HOLDER curved, w/o lock.....	142			

VITRECTOMY 25G

IN

INDEX

Geuder[®]
Precision made in Germany

NUMERICAL INDEX

ITEM NO.	PAGE	ITEM NO.	PAGE	ITEM NO.	PAGE	ITEM NO.	PAGE
G-12...		15189	193	15750	162	16070	36, S16
12200	66	15190	189, S17	15755	166	16075	36
12220	66	15195	189, S17	15757	167	16080	35
		15197	226	15758	163, S9	16105	191
		15200	191, S3, S13	15780	167, S14	16106	194, S2, S4
G-14...		15220	191	15797	44, S18	16115	193, S2
14000	63	15225	195	15799	173, S13	16120	195
14010	64, S14, S16	15226	195	15800	173, S16, S18-S19	16125	195, S2
14020	64, S9	15230	194	15805	173, S13, S16, S18-S19	16130	195, S6
14105	63, S12	15240	194	15810	173, S14	16132	195
14162	65	15250	192, S3-S5, S9, S12	15820	174	16133	195
14165	65	15271	190	15821	174, S13, S19,	16134	194
14180	63	15272	190	S21, S23-S24	16135	194
14185	63	15273	190	15830	174, S18, S19	16136	194
14200	64, S9	15275	192	15840	52	16138	194
14420	63	15310	197, S10	15845	52	16160	156
14480	56	15312	197, S10	15870	51, S15, S16	16161	156
14490	56	15314	197	15875	51, S15, S16	16166	156
14500	56	15315	186	15880	51, S15	16167	156, S2-S4
14530	55, 266	15350	38	15885	51	16169	157
14540	55, 266	15355	38, S16	15900	51, S16	16175	154, 157, S2
14550	55, 266, S13, S15	15360	166	15910	52, S15	16181	154
14570	56	15365	166	15920	31	16182	154
		15370	166	15921	31	16185	155
		15375	191	15925	31	16189	153, 159, S2-S3
G-15...		15376	191	15926	31	16190	159, S12
15020	183, S17	15377	191	15928	32	16191	158
15050	184	15390	165	15945	20	16193	158
15055	184	15391	165	15946	20	16200	65
15065	150, S9	15392	48	15950	21	16205	158
15070	150, S9	15393	48	15951	21	16210	157
15075	150, S9	15400	165	15955	21		
15080	150, S9	15405	165	15956	22	G-17...	
15085	150, S9	15470	164	15960	25, S2-S4, S7-S8,	17000	24
15090	150, S9	15475	164	S10, S12-S13	17001	24
15095	184, S17	15477	163	15961	28, S7, S8	17002	25
15096	184	15480	164	15962	29	17003	25
15105	186	15485	164	15965	25, S14	17004	17
15110	186	15540	37	15966	25, S9, S19, S21,	17005	27
15125	186, S12	15542	37, S16-S17	S23-S24	17006	27
15130	186, S12	15545	37	15970	22	17010	18
15134	104	15550	37	15975	22	17011	18
15136	186	15555	37	15990	23, S14	17015	18
15137	186	15560	37	15995	23, S13, S18	17016	18
15138	186	15620	161, S2, S4			17017	18
15140	189	15630	161	G-16...		17019	27
15141	189, S13	15635	161	16000	24, S18	17020	15, S2, S12, S15
15150	189	15640	161	16010	23	17021	27
15151	189, S3, S13	15645	161	16020	23	17023	15, S13
15160	189	15710	180	16025	23	17024	28
15161	189	15720	162, S19	16030	23	17025	15
15170	190	15725	162	16050	21	17026	15
15180	194, S7	15730	162	16055	21	17027	19
15185	192, S2, S12-S13	15731	162	16060	35, S13, S16, S18	17030	19
15188	193	15740	162	16065	35, S13, S16, S18	17031	29
		15745	162				

ITEM NO.	PAGE	ITEM NO.	PAGE	ITEM NO.	PAGE	ITEM NO.	PAGE
17040	36, S15-S16	18160	136	S23-S24	19026	103
17070	38, S17	18170	135, S16, S21, S23-S24	18820	125, S2, S12, S19	19030	106, S2-S3, S9-S10, S12-S13, S17-S19, S21, S23-S24
17080	38	18171	135, S16	18840	111	19032	107, S2-S3, S13, S19
17085	38	18180	135, S2, S9, S12, S14, S17-S18, S21, S23-S24	18845	111	19034	106
17250	69	18181	135, S13-S14, S17-S18	18846	112	19035	106
17251	69	18182	135, S19	18847	102	19038	107
17260	69	18185	135	18848	102	19040	106, S9-S10, S16, S18
17261	69	18190	136, S2, S18-S19, S21, S23-S24	18850	101, S13, S15	19045	105
17270	69	18195	136	18855	110	19046	105
17271	69	18197	136	18856	110	19048	107
17280	69	18210	75	18857	111	19050	109, S14, S16
17281	69	18220	75	18860	111	19055	109
17290	69	18225	75, S17	18870	111	19060	109
17291	69	18232	77	18880	112	19080	109, S14
17300	69	18235	76	18889	111	19105	126
17440	88, 143	18237	77	18890	111	19107	127
17441	88, 143	18238	76, S12	18897	112	19112	126, S14, S18
17450	139, S9	18239	76, S12	18900	110, S12	19120	127, S18-S19
17451	139	18240	243, S17	18905	110	19125	127, S18-S19
17452	139	18245	243, S17	18906	110	19130	43, S2-S3, S12-S13, S16, S19, S21, S23-S24
17453	139	18300	244, S14	18908	110	19135	43, S18
17460	139	18301	244	18910	110, S2	19137	42, 172, S18
17461	139	18302	244	18911	110	19138	43
17462	139	18620	242, S17	18913	112	19230	48, S12
17463	139	18630	242, S17	18914	119, S7-S8	19270	145
17500	139, S2-S4, S9, S12-S13, S19	18645	44	18918	122	19300	145
17501	139, S19	18650	43, S19	18919	122	19320	145
17505	139, S10	18670	134	18928	123	19330	145
17506	139	18680	134, S15-S16	18930	122	19345	62
17510	140	18685	134, S15-S16	18935	121, S2, S4	19350	91
17511	140	18690	134	18940	105, S14, S17, S21, S23-S24	19355	91, S14, S16-S19
17515	140	18695	134	18941	125	19360	91
17516	140	18700	134	18944	123	19365	91
17520	141	18710	134, S15-S16	18945	105	19370	91
17525	141	18715	134, S16	18950	104, S4, S13, S19	19375	91, S14-S15, S19, S21, S23-S24
17530	140	18720	101	18960	104, S2-S3, S9, S16, S21, S23-S24	19380	91
17535	140	18730	101	18965	104	19385	91
17540	142	18740	101	18966	104	19390	92
17545	142	18750	101	18970	105	19395	92
17560	142	18780	110	18972	104, S9	19400	92, S2-S4, S9, S12
17565	142, S12-S13, S18-S19	18781	110	18975	104	19405	92
17570	142, S14, S21, S23-S24	18782	110, S13-S14, S17-S19, S21, S23-S24	G-19...		19410	92
17575	142, S2, S14-S18	18783	110	19001	103, S9	19420	90
17610	143	18784	110	19005	103, S13, S16, S18-S19	19425	90
17615	143	18790	110	19008	103	19430	90
17640	144	18791	110, S2, S9, S12, S15	19010	103, S9, S13, S16, S18, S21, S23-S24	19435	90
17645	144	18792	110, S12, S14, S15, S19	19015	103	19450	93
17650	144	18793	110	19020	103	19460	91
17660	144	18794	110	19022	103	19465	91
17665	144	18795	126	19023	103, S3	19470	89
G-18...		18800	126	19024	103	19475	89, S18-S19
18127	145, 231, S7-S8	18805	117	19025	103	19480	89, S16
18150	145, S7-S8	18810	102, S16-S18, S21,				

ITEM NO.	PAGE	ITEM NO.	PAGE	ITEM NO.	PAGE	ITEM NO.	PAGE
19485	89, S3, S13-S14, S17, S21, S23-S24	19856	253	20618	69	G-31 ...	
19505	93	19865	257			31013	264
19510	93	19866	257	G-21 ...		31014	266
19520	94	19867	257	21175	72	31016	265
19525	94, S14	19870	256	21176	72	31017	265
19530	94	19876	253, 255			31018	265
19540	86	19877	254-255	G-22 ...		31021	264
19545	86	19890	255	22100	198, S3, S5	31022	265
19550	86	19892	254-255	22101	199, S3, S5	31023	265
19570	82	19899	257	22102	198	31024	265
19580	82	19960	212	22105	199	31025	264
19585	82	19961	212	22106	199	31026	264
19590	83			22107	199	31027	265
19600	82, S16, S18-S19	G-20 ...		22525	205	31028	264
19605	82	20050	69	22527	205	31029	264
19607	82	20054	69	22540	205	31031	265
19615	82	20055	69	22542	205	31034	266
19620	84	20060	69	22545	205	31105	245
19630	84, S12	20065	69	22550	197	31230	102
19640	86	20070	69	22556	205	31235	102
19655	86	20080	69	22615	205	31299	114
19660	87	20090	69	22619	193, S12	31300	113
19675	87	20100	69	22632	198	31301	114
19680	87, S12	20216	245	22633	198	31303	114
19690	81	20217	245	22636	264	31304	113
19695	81	20218	245	22637	199	31305	114, S2-S3
19710	81, S2	20219	245			31306	115
19715	81, S2	20220	245	G-23 ...		31307	113, S4
19718	81	20316	245	23991	231	31308	113
19720	81, S9-S10	20317	245			31315	94
19725	81, S9-S10	20318	245	G-24 ...		31355	192
19727	82	20319	245	24100	204-205	31378	160
19740	83	20320	245	24311	203	31415	136
19745	83	20416	245, S14	24314	204	31420	136
19747	83	20417	245, S14	24318	203	31468	61
19750	89, S2, S9, S12-S13, S16, S18-S19, S21, S23-S24	20418	245, S14	24330	204	31470	61, S12
19751	89	20419	245, S14	24332	204	31477	62
19760	84, S21, S23-S24	20420	245, S14	24418	203	31480	62
19765	84, S2-S4, S9, S13, S15	20450	69	24430	204	31487	62, S12
19770	84, S10	20455	69	24432	204	31490	149
19775	85	20460	69	24435	204	31491	149
19776	83, S2	20465	69	24440	204	31500	151
19777	83	20470	69			31501	151
19780	81	20480	69	G-28 ...		31502	151
19790	81	20490	69	28150	252, 255	31503	151
19820	246	20500	69	28151	252, 255	31504	151
19822	252, 255	20610	69	28752	211	31505	152
19823	252, 255	20611	69	28766	230	31506	152
19825	246	20612	69, S12	28767	230	31507	152-154, S3, S5
19841	255, 257	20613	69	28768	230	31510	193
19842	254-255, 257	20614	69			31518	120
19843	253, 255, 257	20615	69			31519	120
19846	257	20616	69			31520	229
19847	257	20617	69			31545	52, S14
						31555	52, S14

ITEM NO.	PAGE	ITEM NO.	PAGE	ITEM NO.	PAGE	ITEM NO.	PAGE
31570	128	32005	159	32224	42	32714	180
31620	101	32007	159	32225	44, S18	32715	180
31622	108, S4	32010	198	32227	158	32724	160
31623	108	32011	200, S5	32228	42	32726	172, S17
31624	108	32012	200, S5	32229	42, S9	32727	163
31625	107	32014	202	32240	112	32728	159, S10
31649	255	32015	197	32250	89	32729	166
31650	255	32016	201	32260	140	32740	101
31651	255	32017	201	32261	140	32759	193
31652	255	32018	200	32275	157	32760	194
31656	255	32019	200	32276	157	32765	194
31657	258	32023	84	32282	152	32769	196
31659	258	32026	201	32313	243	32771	198
31661	255	32027	179	32315	141	32772	196
31670	263	32028	201	32318	45, S9	32773	198
31720	120, S3	32034	155	32320	141	32774	196
31722	120	32059	202	32321	141	32776	196
31724	121	32100	83	32335	126	32778	198
31727	154	32101	83	32350	127	32785	256
31805	206	32105	83	32355	242, S17	32800	88, S4
31806	206	32115	36	32445	162, S19	32810	88
31807	193	32119	19	32446	163, S21, S23-S24	32811	88
31810	242, S17	32120	35, S13-S15	32500	152-153	32823	125, S4
31815	69	32126	17	32501	153	32905	174
31820	69	32127	17	32505	151, 153-154, S5	32915	173
31825	69	32128	24, S18	32523	159	32920	174, S13, S15, S21, S23-S24
31830	69	32129	17	32527	195	32926	115, S3, S5
31835	69	32130	20	32528	196	32928	115
31840	69	32133	17	32529	195	32935	115, S4
31845	69	32134	19	32530	156	32936	116
31850	69	32135	20	32550	155	32937	116
31855	69	32136	16, S4	32555	156	32938	116
31860	69	32137	16	32556	155	32940	85, S4
31865	69	32138	18	32557	156	32942	85
31870	70	32139	18	32563	160	32944	117, 264, S4
31891	229	32148	16, S3	32564	160, S6	32945	87, S4
31895	192	32149	16	32600	191	32946	87
31899	119	32150	179, S19	32605	191	32947	108, 264, S4, S6
31900	246, S21	32152	179	32614	90	32948	86, 264, S4, S6
31901	124, S3	32153	179	32660	256	32949	108, 143, S4, S6
31902	123	32155	192	32665	212	32955	241
31903	123	32160	153, 155	32670	212	32960	241, S4
31905	124, S4	32161	153	32671	71	32965	241
31908	124	32162	154, S3	32672	71	32970	241, S4
31911	158	32164	153	32674	71	32996	88, S4
31953	111, S16, S19	32165	121	32675	256	32997	125, S4, S6
31962	122	32166	192	32676	257	32998	88, S6
31975	166	32167	192, S11	32677	257		
31980	166	32168	153	32695	258		
31985	166	32169	154	32696	211, 229	G-33...	
31990	165	32180	209	32697	211	33022	64
31994	124, S4	32181	209, S21	32698	211	33025	64
		32182	209	32699	211	33026	64
G-32...		32209	44, S12	32700	231, S14-S15	33045	206
		32210	44, S12	32705	231, S14-S15	33050	207, S21
32004	44	32222	41	32710	231		

ITEM NO.	PAGE	ITEM NO.	PAGE	ITEM NO.	PAGE	ITEM NO.	PAGE
33051	210	33450	209	33873	70	G-34 ...	
33052	210, S21	33451	209	33874	70	34026	217, S2-S3, S13, S16
33053	207	33452	209	33875	70	34031	217
33054	207	33462	228	33876	70	34036	217, S12
33055	210, 265	33463	228	33877	70	34050	217
33056	210	33468	228	33878	70	34051	217, S3
33057	210, 266	33469	228	33879	70	34052	217, S3
33059	266	33470	210	33880	70	34053	217
33065	211	33471	210	33881	70	34054	217
33066	211	33472	210	33882	70	34055	217, S3
33070	207	33473	210	33883	70	34060	217
33071	207	33474	210	33884	70	34061	217
33072	207	33475	210	33885	70	34062	217
33073	207	33482	228	33886	70	34064	217
33075	207, S21	33484	209	33887	70	34081	217
33077	207	33485	209	33888	70	34086	217
33080	258	33486	209	33889	70	34122	217
33090	258	33488	229	33890	70	34126	217
33100	258	33489	229	33891	70	34146	217, S2
33125	242, S17	33494	209	33892	70	34181	217, S21
33135	189	33495	209	33893	70	34191	217
33140	189	33496	209	33894	70	34192	217
33141	265	33650	243, S7	33895	70	34196	217
33142	265	33652	243, S7	33896	70	34197	217
33143	265	33655	243, S7	33897	70	34198	217
33160	190	33657	243, S7	33898	70	34200	224
33170	190	33670	64, S7	33899	70	34205	224
33175	190	33725	41	33909	196, S7	34210	224, S3
33180	190	33726	41	33910	197, S7-S8	34215	224
33185	190	33727	41, S9	33911	197, S7	34220	224
33190	190	33740	41	33912	167, S7-S8	34225	224, S2
33193	186	33741	41	33914	30	34230	224
33194	186, S17	33742	41	33919	26	34235	225
33195	186	33745	45, S7	33920	26, S7	34240	225
33197	190	33746	45, S7	33925	30	34245	225, S5
33198	190, S17	33747	45, S7	33930	167, S8	34255	226
33199	193	33752	127, S19	33935	168	34261	225
33200	136, S12, S19, S21, S23-S24	33755	149	33940	170, S7	34265	226
33416	191, S10	33757	150	33941	108, S8	34270	225
33420	209	33758	150, S3, S8	33942	170	34271	225
33422	191	33759	150, S7-S8	33943	171, S7-S8	34275	227
33425	209, S21	33760	46	33944	172	34280	226
33427	171, S8	33762	46	33950	169, S8	34285	228, S23
33428	118, S7-S8	33763	46, S6	33952	170, S8	34289	227
33429	118, S8	33774	46, S6	33954	170	34290	224, S17
33430	209	33776	47, S6	33958	171	34291	227, S21
33432	128	33777	47, S6	33959	171, S8	34292	228
33434	127	33778	47	33960	119, S8	34293	227, S21
33435	128, S21	33780	42	33961	119, S8	34294	227, S23
33436	128	33781	42	33965	26, S5	34295	228
33437T	128	33785	45	33966	169, S5	34296	227, S23
33438	128	33786	231, S6-S7, S12, S16	33967	169, S5	34297	227, S24
33439	128	33831	129	33968	169, S5	34298	228
33440	121	33870	70	33971	26	34299	227, S24
33441	128	33871	70			34335	226
		33872	70				

ITEM NO.	PAGE	ITEM NO.	PAGE	ITEM NO.	PAGE	ITEM NO.	PAGE
34340	223	36090	259	36504	95	36955	97
34400	227	36202	130	36506	95	36975	97
34480	229	36206	130	36508	95	36985	97
34492	229	36208	130	36512	95		
34497	228	36212	130	36514	95		
34498	228, S23	36214	130	36516	95	G-37...	
34523	223, S2, S4	36216	130	36518	95	37000	206
34602	232	36218	130	36522	95	37002	206, S21, S23-S24
34610	232	36222	131	36524	95	37005	206
34616	232	36226	131	36526	95, S21	37006	206
34618	232	36232	131	36528	95	37010	206, 208, 265
34620	233	36236	131	36532	95, S21	37011	208
34622	233	36242	131	36534	95	37012	208
34624	233	36246	131	36536	95	37015	208
34626	233	36248	131	36538	95	37020	208
34632	234	36252	131	36540	96, S23	37025	208
34634	234	36254	131	36541	96	37035	208
34636	234	36256	130, S21	36546	95	37046	208
34642	234	36258	130	36548	95	37065	208
34644	234	36262	131	36552	95	37080	206, 209, 265
34645	235	36264	131	36554	95	37100	265
34646	234	36266	131	36556	95	37105	265
34647	235	36272	131	36558	95	37130	22
34650	235	36276	130	36562	96	37390	210
34654	235	36278	130	36564	96	37400	43
34656	235	36282	132, S23	36566	96	37410	43, S21, S23-S24
34658	236	36284	132	36568	96	37412	43
34660	236	36286	132	36572	95	37414	43
34664	236	36288	132	36574	95	37418	43
34666	236	36292	130	36576	96, S23	37420	129
34668	237	36294	130	36578	96	37425	150, S21, S23-S24
34672	237	36296	130	36582	96	37430	129, S21, S23
34674	237	36298	130	36584	96	37435	175, S21, S23-S24
34684	237	36302	130	36586	96, S24	37440	149
34686	238	36304	130	36588	96	37445	180
34688	238	36306	130, S21	36600	133	37450	172
34690	238	36308	130	36601	133	37500	175
34710	238	36312	132, S24	36604	97, 266	37503	175
34806	206, 227	36314	132	36655	133	37505	175
34810	223	36316	130	36680	133	37506	175
34811	223	36318	130	36690	133	37511	175, S21
34812	224, S17	36322	132, S24	36695	133	37512	175, S23
34814	224	36324	132	36700	133	37513	175, S24
		36326	131	36705	133	37515	175
G-36...		36328	131	36710	133	37525	175
		36332	130	36715	133	37530	175
36000	244-245, S21, S23-S24	36336	131	36720	133	37535	175
36010	244, 245	36342	132, S23	36740	133	37545	175
36015	244	36344	132	36755	133	37551	175, S21
36020	244	36356	130, S21	36765	133	37555	65
36025	244	36358	130	36900	97	37570	175
36030	244	36362	132, S23	36901	97	37602	184
36035	245	36364	132	36902	97	37604	184
36045	244	36366	132, S24	36915	97	37700	109
36050	245	36368	132	36925	97	37705	109
36065	245	36502	95	36930	97	37710	109

ITEM NO.	PAGE	ITEM NO.	PAGE	ITEM NO.	PAGE	ITEM NO.	PAGE
G-38 ...		39530	261	42301	222	G-61 ...	
38215	86	39535	261	42302	222	61201	220
38232	86	39540	262	42311	221, S23	61202	220
38236	86	39541	260	42319	221	61204	220
38238	86	39542	260	42321	221	61205	220
38240	85, 116, S5	39543	260	42322	221	61231	220
38242	116	39545	261	42323	222	61232	220
38244	116, S5	39546	261	42341	219	61234	220
38246	85, S5	39547	261	42342	219	61235	220
38341	59	39548	260	42343	219	61251	220
38342	60	39549	260	42344	219, S23	61252	220
38343	59	39650	257	42361	218, S23	61254	220
38344	59	39680	251	42362	218	61255	220
38444	60	39741	250	42501	222		
38448	60, S5	39745	249	42502	222	G-80 ...	
38453	61	39746	250	42511	221	80975	226
38466	61	39750	249, S2 - S3, S21, S23 - S24	42521	221		
38473	60	39753	251	42522	221		
38475	59	39754	251	42523	222		
38600	41, S10 - S11	39755	251	42541	219	G-150 ...	
38601	202, S10 - S11	39762	251	42542	219	150001	185
38602	202, S10 - S11	39764	251	42544	219, S24	150002	185
38603	118, S10	39766	251	42561	218, S24	150003	185
38604	168, S10	39782	250, S2 - S3, S21, S23 - S24	42562	218	150004	185
38606	118, 168, S10	39783	249, 250, S2 - S3, S21, S23, S24	G-46 ...		150005	185
38607	168, S10 - S11	39784	249	46001	222	150051	185
38608	168, S10 - S11	39785	249, 250	46002	222	150052	185
38620	71, S11	39786	249, S2 - S3, S21, S23 - S24	46011	221	150053	185
38621	64, S11	39787	250	46021	221	150054	185
38622	168, S11	39788	250	46022	221	150055	185
38623	105, S11	39789	250	46023	222	150101	185, S17
38624	117, S11	39791	250	46041	219, S21	150102	185, S17
38628	117			46042	219	150103	185, S17
38630	223	G-40 ...		46044	219	150104	185
38631	203	40006	218, S21, S23	46301	222	150105	185
38632	203	40008	218	46302	222	150151	185
38634	117, S10 - S11	G-42 ...		46311	221	150152	185
38635	223, S11	42001	222	46321	221	150153	185
G-39 ...		42002	222	46322	221	150154	185
39501	261	42009	222	46323	222	150155	185
39502	262	42011	221, S21	46341	219, S23	150301	183
39503	262	42019	221	46342	219	150302	183, S17
39504	262	42021	221	46343	219, S23	150303	183
39505	263	42022	221	46362	218	150401	183, S15, S17
39511	261	42023	222	46501	222	150402	183
39512	262	42041	219	46502	222	150403	183
39513	262	42042	219	46511	221		
39514	262	42043	219, S21	46521	221	G-500 ...	
39525	259	42044	219, S21	46522	221	500001	215
39526	259, S4 - S5, S7, S12, S14 - S15	42061	218, S21	46523	222		
39527	259			46541	219, S24	G-520 ...	
39528	259			46542	219, S24	520400	215
				46562	218	520500	215

ITEM NO. PAGE ITEM NO. PAGE

520550.....	215	560625.....	216
520600.....	215	560650.....	216
520625.....	215	560675.....	216
520650.....	215	560700.....	216
520675.....	215	560725.....	216
520700.....	215	560750.....	216
520725.....	215	560775.....	216
520750.....	215	560800.....	216, S9
520775.....	215	560825.....	216
520800.....	215	560850.....	216, S9
520825.....	215	560875.....	216
520850.....	215	560900.....	216
520875.....	215	560925.....	216
520900.....	215	560950.....	216
520950.....	215		

G-570...

G-521...		570600.....	216
521000.....	215	570650.....	216
521050.....	215	570700.....	216
521100.....	215	570725.....	216
521150.....	215	570750.....	216, S9
521200.....	215	570775.....	216
521250.....	215	570800.....	216, S9
521300.....	215	570825.....	216
521350.....	215	570850.....	216
521400.....	215	570875.....	216
521450.....	215	570900.....	216
521500.....	215		
521550.....	215		
521600.....	215		
521650.....	215		
521700.....	215		
521800.....	215		

G-540...

540600.....	215
540625.....	215
540650.....	215
540675.....	215
540700.....	215
540725.....	215
540750.....	215
540775.....	215
540800.....	215
540825.....	215
540850.....	215
540875.....	215
540900.....	215
540925.....	215
540950.....	215

G-560...

560600.....	216
-------------	-----

KEYWORD	PAGE	KEYWORD	PAGE	KEYWORD	PAGE
A					
Absorbent Swabs.....	231, S8, 231	Bone Gouge, West.....	243	Chopper, Tobias Neuhann.....	152
A.C. Infusion Cannula.....	S10	Bone Nibbling Rongeur.....	75, S17	Cilia And Foreign Body Forceps..	101, S13, S15
A.C. Infusion Cannula, Bopp.....	S10	Bone Nibbling Rongeur, Beyer.....	75	Cilia And Foreign Body Forceps, Hamburg	Model.....
Adapter.....	264	Bone Nibbling Rongeur, Citelli.....	75	Model.....	101
Anterior Chamber Forceps.....	121	Bone Nibbling Rongeur, Kerrison.....	75, S17	Cilia and Foreign Body Forceps, Shaaf.....	S13
Anterior Chamber Forceps,		Bonn Injection Set.....	238	Cilia And Foreign Body Forceps, Shaaf.....	101
von Barsewisch.....	121	C			
Anterior Chamber Infusion Cannula.....	191	Caliper.....	43, S2-S3, S12-S13, S16,	Cilia And Suture Forceps.....	101
Anterior Chamber Infusion Cannula,		S18-S19, S21, S23-S24	Cilia And Suture Forceps, Barraquer.....	101
Bonn Model.....	191	Caliper, Castroviejo.....	43, S2-S3, S12-S13,	Cilia Forceps.....	101, S15
Anterior Chamber Infusion Cannula,		S16, S18-S19, S21, S23-S24	Cilia Forceps, Barraquer.....	101
Bopp.....	191	Cannula.....	211	Cilia Forceps, Beer.....	101
Anterior Synechia Scissors.....	83	Cannula, Heidelberg Model.....	211	Cilia Forceps, Gradle.....	101
Anterior Synechia Scissors, Castroviejo.....	83	Capsule Forceps.....	S4	Cilia Forceps, Henry.....	101
Aspiration Adapter.....	264	Capsule Forceps, H.-R. Koch.....	S4	Clamp For Infusion Tube.....	27
Aspiration Cannula.....	193-196, 198, 210,	Capsule Polishing Cannula.....	195-196, 226,	Cleaning Adapter.....	97, 264-266
.....	S12, S21	S2, S6	Clear-Cornea-Incision Fixation Ring.....	S3, S8
Aspiration Cannula, Brauweiler.....	196, 198	Capsule Polishing Cannula, Greite.....	196	Clear Cornea Knife.....	217
Aspiration Cannula Handpiece.....	198	Capsule Polishing Cannula, Kratz.....	195, S2	Colibri Forceps.....	104, S2-S4, S9, S13,
Aspiration Cannula Handpiece,		Capsule Polishing Cannula, Kyu.....	195	S16, S19, S21, S23-S24
Brauweiler.....	198	Capsule Polishing Cannula, Papst.....	195	Combined Needle Holder / Scissors.....	88, 143
Aspiration Cannula, H.-R. Koch.....	196	Capsule Polishing Curette.....	160, S6	Conjunctiva Forceps.....	102, S16-S18,
Aspiration Cannula, Roieder.....	210	Capsule Polishing Curette, Rentsch.....	160, S6	S21, S23-S24
Aspiration Cannula, Weber.....	210, S21	Capsule Scissors.....	85-86, S4-S5	Conjunctiva Forceps, Draeger... 102, S16-S18,	
Aspiration Handpiece.....	198-201, 227, S3, S5	Capsule Scissors, Brauweiler.....	85	S21, S23-S24
Aspiration Handpiece, Brauweiler.....	200	Capsule Scissors, H.-R. Koch.....	85, S4	Conjunctiva Forceps, Foerster.....	102
Aspiration Handpiece,		Capsule Scissors, Osher.....	86	Conjunctiva Forceps, Freiburg Model.....	102
D.D. Koch - T. Kohnen.....	198	Capsule Scissors, Yae.....	85, S5	Conjunctiva Forceps, Kaufmann.....	102
Aspiration Handpiece, H.-R. Koch.....	200	Capsulorhexis Forceps.....	113-117, S2-S5	Conjunctiva Forceps, Krefeld Model.....	102
Aspiration Handpiece, Koch-Kohnen.....	S3, S5	Capsulorhexis Forceps, Hattenbach.....	117, S4	Corneal Irrigation Cannula.....	197, S10
Aspiration Handpiece, R. Koch.....	201	Capsulorhexis Forceps, H.-R. Koch.....	114	Corneal Irrigation Cannula, Krumeich.....	197, S10
Aspiration Handpiece, Schmack.....	198-199	Capsulorhexis Forceps, Ikeda.....	1166, S5	Corneal Marker.....	41-42, 45, 47, S7, S9-S11
Aspiration Polishing Cannula.....	195	Capsulorhexis Forceps, Masket.....	113	Corneal Marker, Hoffer.....	41
Aspiration Polishing Cannula, Teping.....	195	Capsulotomy Scissors.....	83-85, S2-S4,	Corneal Marker, Lindstrom.....	42
Aspiration Speculum.....	S7-S8	S9-S10, S12-S13, S15, S21, S23-S24	Corneal Marker, Thomas Neuhann.....	41, S9-S11
Aspiration Speculum,		Capsulotomy Scissors,		Corneal Pendulum Marker.....	46, S6
Liebermann-Tennant.....	S7-S8	Tuebingen Model.....	84, S12	Corneal Pendulum Marker, Scott.....	46, S6
Aspiration Handpiece, Koch-Kohnen.....	S5	Capsulotomy Scissors, Vannas.....	84-85,	Corneal Punch.....	70, S9
B					
Backflush Cannula.....	207, 227-228,	S2-S4, S9-S10, S13, S15, S21, S23-S24	Corneal Punch, Thomas Neuhann.....	70
.....	S21, S23-S24	Cerclage Forceps.....	127	Corneal Scarifier.....	64, 57, S9, S16
Backflush Cannula, Kampik.....	207	Cerclage Forceps, Essen Model.....	127	Corneal Scarifier, Kuhnt.....	64, S9, S14, S16
Backflush Cannula, Laqua.....	207	Chalazion Curette.....	51-52, S15-S16	Corneal Scissors.....	81-82, S2, S16, S18-S19
Backflush Handpiece.....	206, 227, S21, S23	Chalazion Curette, Axenfeld.....	52, S15	Corneal Scissors, Castroviejo.....	81
Backflush Tip.....	208, 209	Chalazion Curette, Hebra.....	52	Corneal Scissors, Katzin.....	81, S9-S10
Backflush Tip, Klein.....	208	Chalazion Curette, Meyhoefer.....	51, S15-S16	Corneal Scissors, Sautter.....	81, 162, 192, 225,
Ball Capsule Polisher.....	160	Chalazion Curette, Meyhoeffer.....	S15	S3-S5, S9, S12
Ball Capsule Polisher, Anis.....	160	Chalazion Forceps.....	134, S15	Corneal Scissors, Troutman.....	81, S2
Battery Cautery.....	246	Chalazion Forceps, Ayer.....	134	Corneal Section Scissors.....	82
Bone Chisel.....	243, S17	Chalazion Forceps, Cauet.....	134	Corneoscleral Punch.....	77
Bone Chisel, West.....	243	Chalazion Forceps, Desmarres.....	134, S16	Corneoscleral Punch, Gass.....	77
Bone Gouge.....	243	Chalazion Forceps, Lambert.....	134, S16	Crescent Knife.....	61
		Chalazion Forceps, Lordan.....	134, S15-S16	Crvo Knife.....	66
		Chalazion Knife.....	63	Crvo Knife, Dithmar.....	66
		Chopper.....	152	Cyclodialysis Spatula.....	164, 192
				Cyclodialysis Spatula Cannula.....	192
				Cyclodialysis Spatula Cannula, Busse.....	192
				Cyclodialysis Spatula, Castroviejo.....	164

KEYWORD	PAGE	KEYWORD	PAGE	KEYWORD	PAGE
Cyclodialysis Spatula, Elschmig.....	164	Duct Trephine.....	69, S12	Eye Speculum, Mellinger-Beard.....	20
D		Duct Trephine, Schmidt-Mumm.....	69, S12	Eye Speculum, Murdock.....	24-25
Dalk Probe.....	186	E		Eye Speculum, Noda.....	27-29
Dalk Probe, Krumeich.....	186	Elevatorium.....	242, S17	Eye Speculum, Ohno.....	17
DCR Lacrimal Intubation Set.....	224	Elevatorium, Heidelberg Model.....	242, S17	Eye Speculum, Paulmann.....	27
Degree Gauge.....	46	Enclavation Spatula.....	160	Eye Speculum, Pretori.....	21
Degree Gauge, Mendez.....	46	Enclavation Spatula, Sekundo.....	160	Eye Speculum, Sauer.....	19
Descemet Incision Hook.....	168, S10-S11	Endothelial Insertion Spatula.....	168	Eye Speculum, Schott.....	31-32
Descemet Membrane Forceps.....	117	Endothelial Insertion Spatula, Thomas Neuhann.....	168	Eye Speculum, Takeda.....	19
Descemet Membrane Forceps, Tobias Neuhann.....	117	Enucleation Scissors.....	94, S14	Eye Speculum, Thomas Neuhann.....	19
Descemet Punch.....	S12	Enucleation Spoon.....	167, S14	Eye Speculum, Weiss.....	21-22
Descemet Punch, Kelly.....	S12	Enucleation Spoon, Wells.....	167, S14	Eye Sphere.....	245, S14
Descemet Scraper.....	168, S10-S11	Enzyme Cannula.....	191	Eye Sphere, Cibis.....	245
Descemet's Membrane Punch.....	76	Ergoline Forceps.....	133	Eye Sphere, Harms.....	245
Descemet's Membrane Punch, Kelly.....	76	Ergoline Forceps ILM.....	133	Eye Sphere, Walser.....	245, S14
Diaclean CCI Diamond Knife.....	55	Ergoline Forceps ILM, Naito.....	133	F	
Diaclean Clear-Cornea-Incision		Ergoline Forceps, Tano.....	133	Fascia Needle.....	243
Diamond Knife, 1.5/2.0 mm.....	60	Ergoline Scissors.....	97	Fascia Needle, Wright.....	243
Diaclean Clear-Cornea-Incision		Ergoline Scissors, Heimann.....	97	Femtocataract Eye Speculum.....	26, S5
Diamond Knife, 2.2 mm.....	60	Ergoline Scissors, Kroll.....	97	Femtocataract Eye Speculum, Dick.....	26, S5
Diaclean Clear-Cornea-Incision		Ergoline Scissors, Naito.....	97	Femtocataract Eye Speculum, Solomon.....	26
Diamond Knife, 2.85 mm.....	61	Exenteration Curette.....	52, S14	Femtocataract Nucleus Rotator and Chopper.....	169, S5
Diaclean Diamond Crescent Knife.....	61	Exenteration Curette, Bunge.....	52, S14	Femtocataract Nucleus Rotator and Chopper, Hoffmann.....	169, S5
Diaclean Diamond Knife.....	59	Explantation Forceps.....	125, S4	Femtocataract Spatula.....	169, S5
Diaclean Tri-Facet Diamond Knife.....	60	Explantation Hook.....	157	Femtocataract Spatula, Breyer.....	169, S5
Diaclean Tri-Facet Diamond Knife, Pham.....	60	Explantation Hook, Tandogan.....	157	Femtocataract Spatula, Dick.....	169, S5
Diamond Burr.....	244, S14	Expressor Cannula.....	193	Femto Double Instrument.....	169, 170, S8
Diamond Knife.....	59- 62, S12	Expressor Cannula, Klöckner.....	193	Femto Double Instrument, Chansue.....	169, 170, S8
Diamond Micrometer Knife.....	62	Eye Douche.....	191, S3, S13	Femto Double Instrument, Guell.....	170
DMEK Graft Retainer.....	71, S11	Eye Douche, Cranz.....	191, S3, S13	Femto Flap Lifter.....	171
DMEK Graft Retainer, Szurman.....	71, S11	Eye Scissors.....	91-93, S2-S4, S9, S12, S14-S19, S21, S23-S24	Femto Flap Lifter, Pfaeffl.....	171
DMEK Irrigation Handpiece.....	203	Eye Scissors, Bonn Model.....	92, S2, -S4, S9, S12	Femto-LASIK Double-Ended Instrument.....	170, 172
DMEK Irrigation Handpiece, Szurman.....	203	Eye Scissors, Graefe.....	93	FemtoLASIK Double-Ended Instrument, Breyer.....	170
DMEK Keratoplasty Forceps.....	105, S11	Eyeshield.....	245	FemtoLASIK Double-Ended Instrument, Kohnen.....	172
DMEK Keratoplasty Forceps, Remky.....	105, S11	Eye Speculum.....	15-32, 223, S2-S5, S7-S10, S1-S15, S18-S19, S21, S23-S24	Femto-LASIK Flap Forceps.....	118, S8
DMEK Preparation Forceps.....	117, S11	Eye Speculum, Bangarter.....	23	Femto-LASIK Flap Forceps, Knorz.....	118, S8
DMEK Preparation Forceps, Szurman.....	117, S11	Eye Speculum, Barraquer.....	15-17, 19, S2-S4, S12-S13, S15	Femto-LASIK Hook.....	S8
DMEK Preparation Scraper.....	64, S11	Eye Speculum, Barraquer Frankfurt Model.....	16	Femto-LASIK Hook, Breyer.....	S8
DMEK Preparation Scraper, Szurman.....	64, S11	Eye Speculum, Barraquer-Oosterhuis.....	18	Femto-LASIK Hook Instrument.....	171
DMEK Preparation Spatula.....	168, S11	Eye Speculum, Bartl.....	22	FemtoLASIK Hook Instrument, Breyer.....	171
DMEK Preparation Spatula, Szurman.....	168, S11	Eye Speculum, Castroviejo.....	23	Femto-LASIK Round Spoon.....	170, S7
DMEK Transplant Forceps.....	117	Eye Speculum, Cook.....	23-24, S13-S14, S18	Femto-LASIK Round Spoon, Blum.....	S7
DMEK Transplant Forceps, Yörük.....	117	Eye Speculum, Cook.....	23-24, S13-S14, S18	FemtoLASIK Round Spoon, Blum.....	170
Dressing Forceps.....	110, S2, S9, S12-S15, S17-S19, S21, S23-S24	Eye Speculum, Kammann.....	29	Fixation And Holding Forceps.....	122
DSAEK/DMEK Rhexis Forceps.....	117, S10-S11	Eye Speculum, Kershner.....	25, S9, S14, S19, S21, S23-S24	Fixation And Holding Forceps, Dick.....	122
DSAEK/DMEK Rhexis Forceps, Gerten.....	117, S10-S11	Eye Speculum, Koga / Noda.....	28	Fixation Forceps.....	109, S14, S16
DSAEK Forceps.....	118, S10	Eye Speculum, Kratz-Barraquer.....	17, 19	Fixation Forceps, Barraquer.....	109, S14
DSAEK Forceps, Thomas Neuhann.....	118, S10	Eye Speculum, Liebermann-Tennant.....	25, 28, S2-S4, S7-S8, S10, S12-S13	Fixation Forceps, Barraquer.....	109, S14
DSAEK Implantation Forceps.....	118, S10	Eye Speculum, Mellinger.....	20	Fixation Forceps, Graefe.....	109, S14, S16
DSAEK Insertion Spatula.....	S10				
DSAEK Insertion Spatula, Thomas Neuhann.....	S10				

KEYWORD	PAGE	KEYWORD	PAGE	KEYWORD	PAGE
Althaus/Cartsburg.....	202, S10-S11	Lacrimal Probe, Wilder.....	183, S15, S17	Lens Loop, Snellen.....	161
Irrigation Descemet Scraper.....	202, S10-S11	Lacrimal Sac Retractor.....	37-38, S16-S17	Lens Loop, Spirig.....	161
Irrigation Descemet Scraper,		Lacrimal Sac Retractor, American Model.....	38	Lens Loop, Weber.....	161
Neuhann.....	202, S10-S11	Lacrimal Sac Retractor, Axenfeld. 37, S16-S17		Lens, Machemer.....	244
Irrigation Handpiece.....	198-201, 203, 227,	Lacrimal Sac Retractor, Goldstein.....	38	Lens Manipulation Hook.....	156, S2-S4
.....	S3, S5	Lacrimal Sac Retractor, Mueller.....	38	Lens Manipulation Hook, Sinskey..	156, S2-S4
Irrigation Handpiece, Brauweiler.....	201	Lacrimal Sac Retractor, Rollet.....	37	Lens Manipulator.....	155-158
Irrigation Handpiece,		Lasek Epi Peeler.....	64	Lens Manipulator and Hook.....	156
D.D. Koch - T. Kohnen.....	199	Lasek Epi Peeler, Lohmann.....	64	Lens Manipulator and Hook, Rentsch.....	156
Irrigation Handpiece, Koch-Kohnen.....	S3, S5	LASEK Epi Peeler, Lohmann.....	S7	Lens Manipulator, Bremen Model.....	156
Irrigation Handpiece, Schmack.....	198	LASEK Funnel.....	243, S7	Lens Manipulator, Jacobi.....	156
Irrigation Trabeculotomy Cannula.....	193	LASEK Funnel, Lohmann.....	243, S7	Lens Manipulator, Mainz Model.....	155
Irrigation Trabeculotomy Cannula, Burk.....	193	LASEK Spatula.....	168	Lens, Peyman.....	244
Irrigation Vectis Cannula.....	193, 226, S2	LASEK Trephine.....	243, S7	Lens Spatula.....	157
J		LASIK Cannula.....	196, S7	Lens Spatula, Hirschmann.....	157
Jewelers Type Forceps.....	109	LASIK Cannula, Bauer.....	S7	Lens, Tolentino.....	244
K		LASIK Cannula, W. Bauer.....	196	Lenticule Forceps.....	119, S8
Karate Phaco Chopper.....	152	LASIK Corneal Flap Forceps.....	119	Lenticule Forceps, Rupal Shah.....	119
Karate Phaco Chopper, Agarwal.....	152	LASIK Corneal Flap Forceps, Buratto.....	119	Lenticule Micro Forceps.....	S8
Keratome.....	63	Lasik Corneal Marker.....	45, S7	Lenticule Micro Forceps, Rupal Shah.....	S8
Keratome, Hamburg Model.....	63	LASIK Corneal Marker.....	S7	Lid Plate.....	36, S15-S16
Keratometer.....	45, S9	Lasik Corneal Marker, Chayet.....	45	Lid Plate, Jaeger.....	36, S15-S16
Keratometer, Maloney.....	45, S9	LASIK Corneal Marker, Chayet.....	S7	Lid Retractor.....	35-36, S13-S16, S18
Keratoplasty Forceps.....	104-105, S9	Lasik Corneal Marker, Lu.....	45	Lid Retractor, Desmarres.....	35-36,
Keratoplasty Forceps, Remky.....	105	LASIK Corneal Marker, Lu.....	S7	S13-S16, S18
Keratoplasty Forceps,		Lasik Corneal Marker, Mendez.....	45	Lid Retractor, Giessen Model.....	36
Thomas Neuhann.....	104, S9	LASIK Corneal Marker, Mendez.....	S7	Limbal Relaxing Incision Diamond Knife.....	61
Keratoplasty Knife.....	64, S9	LASIK Corneal Protector.....	167, S7-S8	Localizer and Scleral Depressor.....	180
Keratoplasty Knife, Paufigue.....	64, S9	LASIK Corneal Protector, Zirm.....	167, S7-S8	Localizer and Scleral Depressor,	
Keratoplasty Scissors.....	81-82, S9-S10	LASIK Dissector Cannula.....	197, S7-S8	Meyer-Schwickerath.....	180
Keratoplasty Scissors, Katzin.....	S9-S10	LASIK Dissector Cannula, Zirm.....	197, S7-S8	M	
Keratoplasty Scissors, Mackensen.....	82	Lasik Eye Speculum.....	26, 30	Manipulator.....	154-158
Keratoplasty Spatula.....	163, S9	LASIK Eye Speculum.....	S7	Manipulator, Frankfurt Model.....	156
Keratoplasty Trephine.....	69-70	Lasik Eye Speculum, Knorz.....	26	Manipulator, Mainz Model.....	155
Keratoplasty Trephine, Best.....	69	LASIK Eye Speculum, Knorz.....	S7	Marker.....	S7, S12, S18
Keratoplasty Trephine, Franceschetti.....	69	Lasik Eye Speculum, Maus.....	30	Marker, Fink.....	S18
Keratoplasty Trephine, Hamburg Model.....	69	LASIK Eye Speculum, Zirm.....	30	Marker, Fronimopoulos.....	S12
L		LASIK Flap Forceps.....	S7, S8	Marking Instrument.....	S21, S23-S24
Lacrimal Cannula. 189-190, 224, S3, S13, S17		LASIK Flap Forceps, Buratto.....	S7, S8	Marking Pen.....	231, S6-S7, S16, 231
Lacrimal Cannula, Anel.....	189, S17	LASIK Irrigation Cannula.....	197, S7	Measuring Spatula.....	44
Lacrimal Cannula, Bonn Model.....	190	LASIK Irrigation Cannula, Zirm.....	197, S7	Measuring Spatula, Engels.....	44
Lacrimal Intubation Set.....	223-224, S17	LASIK Spatula.....	167, S8	Melag Metal Grid Insert.....	263
Lacrimal Intubation Tubing.....	223	LASIK Spatula, Neuhann.....	S7	Membrane Peeler.....	175, S21, S23-S24
Lacrimal Probe... 183, 185-186, 190, S15, S17		LASIK Spatula, Rau.....	168	Membrane Peeler, Morris-Kroll.....	175
Lacrimal Probe, Bowman.....	185, S17	LASIK Spatula, Thomas Neuhann.....	167	Membrane Spatula, Lucke.....	175, 179
Lacrimal Probe Cannula.....	190, S17	Lens.....	88, 244, 245, S2, S4, S21, S23, S24	Meridional Silicone Implant (106 Style).....	235
Lacrimal Probe Cannula, Bangertner.....	190	Lens Extraction Hook.....	155	Metal Stand.....	72
Lacrimal Probe Cannula, Juenemann. 190, S17		Lens Extraction Hook, Hennig / Friedrich... 155		Micro Colibri Forceps.....	104, S2-S3, S9,
Lacrimal Probe, Giessen Model.....	183, S17	Lens Handle Ring.....	245	S16, S21, S23-S24
Lacrimal Probe, Juenemann.....	186, 190, S17	Lens, Kilp.....	244, S21, S23-S24	Microfinger.....	154
		Lens, Landers.....	244	Microfinger, Liebermann.....	154
		Lens Loop.....	157, 161, S2	Micro Forceps.....	116, S8
		Lens Loop, Arlt.....	161, S2, S4	Micro Forceps, Tobias Neuhann.....	116
		Lens Loop Manipulator.....	157	Micro Round Knife.....	63, S12
		Lens Loop Manipulator, Lester.....	157		
		Lens Loop Manipulator, Zirm.....	157		

KEYWORD	PAGE	KEYWORD	PAGE	KEYWORD	PAGE
Micro Stitch Scissors.....	82	NanOEdge Trephines.....	215	Oval Silicone Sleeve (3084 Style).....	235
MICROSTO Container high.....	S21, S23-S24	NanOEdge Vacuum Corneal Punch.....	S9	Oval Silicone Sponge Implant (501 Style).....	236
MICROSTOP Clip for Retainer Elements.....	250	NanOEdge Vacuum Trepine.....	216, S9	Oval Silicone Sponge Implant (506 Style).....	236
MICROSTOP Container high.....	249	NanOEdge Vacuum Trepine Punches.....	216	Oval Silicone Sponge Implant (507 Style).....	237
MICROSTOP Container High.....	S2-S3	NanOEdge Vacuum Trepine radial.....	216		
MICROSTOP Container low.....	249	Nasal Forceps.....	127	P	
MICROSTOP ID Label.....	250	Nasal Forceps, Troeltsch.....	127	Paracentesis Knives.....	217
MICROSTOP Label.....	250	Nasal Speculum.....	242, S17	Pendulum Instrument.....	47
MICROSTOP Logistic Frame.....	251	Needle Holder.....	88, 139-144, S2-S4,	PEP 2.2 mm I/A Handpiece.....	203
MICROSTOP Retainer Element.....	250, S2-S3,	S9-S10, S12-S19, S21, S23-S24	PEP 2.2 mm Infusion Sleeve.....	203
.....	S21, S23-S24	Needle Holder, Arruga.....	144	PEP 2.4 mm I/A Handpiece.....	204
MICROSTOP Seal.....	251	Needle Holder, Barraquer.....	139-141, S2-S4,	PEP 2.4 mm Infusion Sleeve.....	204
MICROSTOP Tag.....	251	S9-S10, S12-S13, S19	Permanent Textile Filter.....	255
MICROSTOP Tray Lid mini.....	250	Needle Holder, Barraquer-Troutman.....	140	PFCL Cannula.....	210, 228, S23
MICROSTOP Tray mini.....	249, S2-S3, S21,	Needle Holder, Boynton.....	144	PFCL Cannula, Chang.....	210
.....	S23-S24	Needle Holder, Castroviejo.....	142, S2,	Phaco Spatula.....	159
Micro Trabeculectomy Punch.....	76	S12-S19, S21, S23-S24	Phaco Spatula, Amon.....	159
Micro Trabeculectomy Punch, Grehn.....	76	Needle Holder, Heidelberg Model.....	144	Phaco Spatula, D. D. Koch.....	159
MICS Capsule Forceps.....	115-116	Needle Holder, Jacobi.....	139, S9	Phaco Spoon.....	159
MICS Capsule Forceps, H.-R. Koch.....	115-116	Needle Holder, Kalt.....	143	Phaco Spoon, Engels.....	159
MICS Capsulorhexis Forceps.....	115-116, S5	Nucleus Dividing Hook.....	151-154, S3, S5	Pigtail Probe.....	184, S17
MICS Capsulorhexis Forceps, Auffarth.....	S5	Nucleus Dividing Hook, Haefliger.....	152	Prechopper.....	120, S3
MICS Capsulorhexis Forceps, Ikeda.....	116	Nucleus Dividing Hook, Miyoshi.....	151	Prechopper, Akahoshi.....	120, S3
MICS Capsulorhexis Forceps, Inamura.....	115	Nucleus Dividing Hook, Nagahara.....	152-153,	Prefolder.....	124
MICS Capsulorhexis Forceps, Kampik.....	115	S3, S5	Prefolder, H.-R. Koch.....	S4
MICS Double Cross Action		Nucleus Dividing Hook,		Pressure Tube.....	211
Capsulorhexis Forceps.....	115, S3	Thomas Neuhann.....	151, S5	Probe for Stromal Channel.....	184
MICS Double Cross Action		Nucleus Dividing Hook, Völcker.....	151	Protocol Cards.....	251
Capsulorhexis Forceps, Auffarth.....	115, S3	Nucleus Dividing Hook, Zirm.....	151	Ptosis Forceps.....	134, S16
Mosquito Forceps.....	135, S2, S9, S12-S14,	Nucleus Manipulator and Anterior		Ptosis Forceps, Berke.....	134, S16
.....	S16-S19, S21, S23-S24	Capsule Polisher.....	155	Punch.....	S9, S12
Mosquito Forceps, Halstead.....	135, S2, S9,	Nucleus Manipulator and Anterior			
.....	S12-S14, S17-S19, S21, S23-S24	Capsule Polisher, Drysdale.....	155		
Mosquito Forceps, Hartmann.....	135, S16,	Nucleus Rotator.....	153, 155, 169	R	
.....	S21, S23-S24	Nucleus Rotator and Chopper.....	153	Raspatory.....	242, S17
Muscle Forceps.....	126-127, S14, S18-S19	Nucleus Rotator and Dividing Hook.....	153	Raspatory, Heidelberg Model.....	242, S17
Muscle Forceps, Bangerter.....	126, S14, S18	Nucleus Rotator and Dividing Hook,		Razor Blade Holder.....	145
Muscle Forceps, Sattler.....	127, S18-S19	Thomas Neuhann.....	153	Razor Blade Holder, Barraquer.....	145
		Nucleus Rotator, Thomas Neuhann.....	153, 155	Razor Blade Holder, Castroviejo.....	145
		Nucleus Rotator, Thomas Neuhann		Razor Blade Holder, Troutman.....	145
		and Chopper, Tobias Neuhann.....	153	Razor Blades.....	145
		Nucleus Spreading Forceps.....	120	Retainer For Pendulum Instrument.....	47
		Nucleus Spreading Forceps, Akahoshi.....	120	Retina Diamond Knife.....	62
		Nucleus Sustainer.....	154	Retinal Tack.....	128
		Nucleus Sustainer, Akahoshi.....	154	Retinal Tack, Heimann.....	128
				Retractor.....	38, S2, S4, S13-S18
		O		Retractor, Guthrie.....	38, S16
		Oculopressor.....	48	Retrolubar Injection Cannula.....	191
		Oculopressor, Homburg Model.....	48	Retrograde Probe.....	184
		Operating Scissors.....	94	Retrograde Probe, Kellnar.....	184
		Orbital Spatula... 162-163, S19, S21, S23-S24		Rongeur.....	75, 242, S17
		Orbital Spatula, Behrens-Baumann.....	162	Rongeur, Friedmann.....	242, S17
		Orbital Spatula, Hamburg Model.....	162, S19	Round Silicone Sponge Implant (503 Style).....	235
		Orbital Spatula, Sautter.....	162	Round Silicone Sponge Implant	
		Oval Silicone Sleeve (3083 Style).....	235	(504 Style).....	236

KEYWORD	PAGE	KEYWORD	PAGE	KEYWORD	PAGE
Round Silicone Sponge Implant (505 Style).....	236	Silicone Chamber	206, 227	Sautter.....	225, S5
Ruler.....	44, S19	Silicone Circling Band (40 Style).....	233	Single-Use Hydrodissection Cannula, Tuebingen Model	225
Ruler, Giessen Model.....	44	Silicone Circling Band (240 Style).....	233	Single-Use I/A Cannula.....	226
S		Silicone Closure	258	Single-Use I/A Cannula, Simcoe.....	226
Safety Seal.....	258	Silicone Insert.....	72	Single-Use Infusion Cannula.....	228
Sato Knife.....	65	Silicone Lens Bi-Sector.....	88, S4	Single-Use Infusion Tube 20G UNO Colorline.....	222
Sato Knife, Dardenne.....	65	Silicone Lens Bi-Sector, H.-R. Koch.....	88, S4	Single-Use Injection Cannula.....	226, 229
Sato Knife, Foerster.....	65	Silicone Nap Strip blue.....	257	Single-Use Injection Cannula, Kirchhof.....	229
Sato Knife, Hansen.....	65	Silicone Perforated Tray.....	256	Single-Use Iris Retractor.....	223, S2, S4
Scalpel Handle.....	231, S14-S15	Silicone Plate.....	257	Single-Use Irrigation Cannula.....	226
Scalpel Surgical Blades.....	231, S14-S15	Silicone Replacement Ring.....	244-245	Single-Use Irrigation Vectis Cannula.....	226
Scissors.....	218, 143, S2-S6, S9-S10, S12-S14, S16-S19, S21, S23-S24	Silicone Sleeve (70 Style).....	234	Single-Use Knives.....	217
Scissors, Barraquer.....	S12	Silicone Sleeve (72 Style).....	234	Single-Use Lacrimal Cannula.....	224, S17
Scissors, Westcott...89, S2, S9, S12-S13, S16, S18-S19, S21, S23-S24		Silicone Sleeve (270 Style).....	234	Single-Use Mini Filter.....	229
Scleral Depressor.....	179-180, S15, S19	Silicone Strip (41 Style).....	233	Single-Use Oil Injection System.....	230
Scleral Depressor, Kreissig.....	179	Silicone Strip (42 Style).....	233	Single-Use Peribulbar Cannula.....	224
Scleral Depressor, Laqua.....	179, S19	Silicone Strip blue.....	257	Single-Use PFCL Cannula.....	228, S23
Scleral Depressor, Lucke.....	179	Silicone Tire (276 Style).....	232	Single-Use Pressure Tube.....	229
Scleral Depressor, Schocket.....	180	Silicone Tire (277 Style).....	232	Single-Use Retrobulbar Cannula.....	224, S3
Scleral Fixation Ring.....	150	Silicone Tire (279 Style).....	232	Single-Use Retrobulbar Cannula, Atkinson.....	224, S3
Scleral Fixation Ring, Flieringa.....	150	Silicone Tire (287 Style).....	232	Single-Use Silicone Chamber.....	227
Scleral Flap Marker.....	44, S12	Silicone Tray.....	256	Single-Use Syringe.....	229
Scleral Flap Marker, Tobias Neuhann...44, S12		Silicone Wedge (137 Style).....	235	Single-Use Tano Forceps.....	S24
Scleral Knife.....	63	Single-Use A. C. Cannula.....	225	Single-Use Tano Forceps UNO Colorline.....	219
Scleral Knife, Bonn Model.....	63	Single-Use A. C. Cannula, Rycroft.....	225	Single-Use Three-Way Stop Cock.....	231
Scleral Plug.....	128, S21	Single-Use A. C. Maintainer.....	225	Single-Use Trocar Plugs UNO Colorline.....	221
Scleral Plug Forceps.....	128	Single-Use A. C. Maintainer, Lewicky.....	225	Single-Use Trocar System One-Step UNO Colorline.....	221
Scleral Ruler.....	44, S18	Single-Use Backflush Cannula.....	S24	Single-Use Trocar System One-Step UNO Colorline.....	221
Scleral Ruler, Vogt.....	44, S18	Single-Use Backflush Cannula.....	227-228, S21, S23-S24	Single-Use Vitreous Forceps Crocodile Design.....	219, S21, S23
Seal.....	258	Single-Use Backflush Handpiece.....	227	Single-Use Vitreous Forceps Endgripping.....	219, S23-S24
Seal / Label.....	261	Single-Use Bimanual I/A Handpiece Set.....	227	Single-Use Vitreous Forceps Wave Design UNO Colorline.....	219
Security Seal.....	262	Single Use Cannula.....	228, S23	Single-Use Vitreous Forceps Wave Design UNO Colorline, Hattenbach.....	219
Semi-Circular Silicone Sponge Implant (510 Style).....	237	Single-Use Capsule Polishing Cannula.....	226	Single-Use Vitreous Scissors UNO Colorline.....	218, S24
Semi-Oval Silicone Sponge Implant (511 Style).....	238	Single-Use Capsule Polishing Cannula, Kratz.....	226	Spare Silicone Tube.....	210
Semi-Oval Silicone Sponge Implant (515 Style).....	238	Single-Use Cystotome Cannula.....	224, S2	Spare Tip.....	246
Semi-Oval Silicone Sponge Implant (517 Style).....	238	Single-Use DMEK Cartridge.....	S11	Spare Tubing Set.....	26
Serrefine.....	136, S2, S18-S19, S21, S23-S24	Single-Use DMEK-Cartridge.....	223	Spatula.....	44, 153, 158-159, 162-163, 166-167, 192, S2-S3, S5, S7, S10, S12, S19, S21, S23-S24
Serrefine, Dieffenbach.....	136, S2, S18-S19, S21, S23-S24	Single-Use DMEK Cartridge, Szurman.....	S11	Spatula and Dividing Hook, Thomas Neuhann.....	153
Silicone Ball.....	48	Single-Use DMEK-Cartridge, Szurman.....	223	Spatula and Nucleus Dividing Hook.....	153
Silicone Block.....	71	Single-Use Endo-Probe C UNO Colorline.....	220	Spatula and Retractor.....	167
Silicone Block for DMEK.....	71	Single-Use Endo-Probe S UNO Colorline.....	220	Spatula and Retractor, Giessen Model.....	167
Silicone Block for DMEK, Örk Linz Model.....	71	Single-Use Eye Speculum.....	223	Spatula, Bangerter.....	162, S19
Silicone Block With Center Point.....	71	Single-Use Fiber Optic S UNO Colorline.....	221	Spatula, Essen Model.....	166
Silicone Bulb.....	212	Single-Use Fiber Optic WS UNO Colorline.....	222		
Silicone Bulb.....	S15	Single-Use Fiber Optic W UNO Colorline.....	221		
Silicone Burl Mat.....	257, 262	Single-Use Forceps, Tano.....	S24		
		Single-Use High Speed Vitreous Cutter MACH 2 UNO Colorline.....	222		
		Single-Use High Speed Vitreous Cutter UNO Colorline.....	222		
		Single-Use Hydrodissection Cannula.....	225, S5		
		Single-Use Hydrodissection Cannula, Frankfurt Model.....	225		
		Single-Use Hydrodissection Cannula,			

KEYWORD	PAGE	KEYWORD	PAGE	KEYWORD	PAGE
Spatula, Rentsch.....	159, S10	Superior Rectus Forceps, Remky	125, S2, S12, S19	Triangle Scleral Depressor, Hattenbach.....	180
Spatula, Spirig.....	158	Suture Hook.....	172, S17	Tri-Facet Diamond Step Knife.....	61, S12
Spatula, Steinmetz.....	158	Suture Hook, Muenster Model.....	172, S17	Trocar Closure Forceps.....	129
Spatula, Thomas Neuhann and Nucleus Dividing Hook, Nagahara.....	153	Suture Marker.....	42, S9	Trocar Closure Forceps, Bartz-Schmidt.....	129
Speculum.....	S2 -S3, S7 -S8, S14, S23 -S24	Suture Marker, Duncker.....	42, S9	Trocar Forceps.....	129, S21, S23
Spreading Forceps.....	120, 127, S19	Suture Marker, Thomas Neuhann.....	42	Tying Forceps.....	105 - 108, S2 -S4, S9 -S10, S12 -S13, S16 -S19, S21, S23 -S24
Spreading Forceps, Watzke.....	127, S19	Suture Removing Forceps.....	104, S15	Tying Forceps, Bangerter.....	107
Sterilization Case.....	252 - 255, 257 - 259	Suture Removing Forceps, Barraquer.....	104	Tying Forceps, Bonn Model.....	106
Sterilization Rack.....	256	Suture Tool.....	172	Tying Forceps, Dardenne.....	107
Sterisafe Duro A4.....	259	Suture Tool, Bonn Model.....	172	Tying Forceps, Paufigue.....	105
Sterisafe Duro A4 Plus.....	259	Suturing Forceps.....	103 - 105, S3, S9, S13 -S14, S16 -S19, S21, S23 -S24	Tying Forceps, Tuebingen.....	S9
Sterisafe Duro A4 Plus Complete Set.....	259, S4 -S5, S7, S12, S14 -S15	Suturing Forceps, Castroviejo.....	103, S3, S9, S13, S16, S18 -S19, S21, S23 -S24	Tying Forceps, Tuebingen Model.....	106, S2 -S3, S10, S12 -S13, S16 -S19, S21, S23 -S24
Sterisafe Duro A6.....	259	Suturing Forceps, Munich Model.....	103		
Sterisafe Duro Metal Tray A4-15.....	260	Suturing Forceps, Zuerich Model.....	104	U	
Sterisafe Duro Metal Tray A4-30.....	260	Synechiaes spatula.....	163	Universal Prechopper.....	121
Sterisafe Duro Metal Tray A6-15.....	260	Synechiaes spatula, Binkhorst.....	163	Universal Prechopper, Akahoshi.....	121
Sterisafe Duro Wire Basket A4-30.....	260	Synechiaes spatula, Castroviejo.....	163	Universal Prefolder, H.-R. Koch.....	124
Sterisafe Duro Wire Basket A6-30.....	260	Syringe Clip.....	212	Universal Suturing Forceps.....	105, S14, S17, S21, S23 -S24
Sterisafe Filter.....	261	Syringe Holder.....	211	Universal Suturing Forceps, Paufigue.....	105, S14, S17, S21, S23 -S24
Sterisafe Filter Tag Expiration Date.....	261			UNO Colorline Forceps.....	219, S21, S23 -S24
Sterisafe Metal Grid Insert.....	262 - 263	T		UNO Colorline Forceps, Tano.....	219, S21
Sterisafe Silicone Burl Mat.....	262	Temporal Approach Eye Speculum.....	17	UNO Colorline Single-Use Instruments.....	218 - 222
Sterisafe Silicone Grid Insert.....	262	Temporal Approach Eye Speculum, H.-R. Koch.....	17	UNO Colorline Trocar System.....	223, S21, S23
Sterisafe Silicone Retainer Strip 75.....	261	Tenotomy Scissors.....	89, 90, S3, S13 -S14, S16 -S19, S21, S23 -S24	UNO Colorline Trocar System, Hattenbach / Nikolic.....	S21, S23
Sterisafe Silicone Retainer Strip 145.....	261	Tenotomy Scissors, Bonn Model.....	90	UNO Colorline Vitreous Forceps.....	219, S24
Sterisafe Silicone Retainer Strip 230.....	261	Tenotomy Scissors, Stevens.....	89, S3, S13 -S14, S16 -S19, S21, S23 -S24	UNO Colorline Vitreous Forceps Crocodile Design.....	219, S21, S23
Stiletto.....	64	Tissue Forceps.....	110	UNO Colorline Vitreous Forceps, Hattenbach.....	219, S24
Stitch Scissors.....	82, 92	Tomark Adjustable Corneal Marker.....	47	UNO Colorline Vitreous Scissors.....	218, S21, S23, S24
Stitch Scissors, Spencer.....	92	TOMARK Adjustable Corneal Marker.....	S6	U-Shaped Probe.....	186
Stopper.....	211	TOMARK Pendulum Instrument.....	47, S6	U-Shaped Probe, Thomas Neuhann.....	186
Strabismus Hook.....	173 - 174, S13 -S16, S18 -S19, S21, S23 -S24	Tonometer.....	48, S12		
Strabismus Hook, Bonn Model.....	174, S13, S19, S21, S23 -S24	Tonometer, Schioetz.....	48, S12	V	
Strabismus Hook, Graefe.....	173, S13 -S14, S16, S18 -S19	Towel Forceps.....	136, S12, S19, S21, S23 -S24	Visual Axis Marker.....	45
Strabismus Hook, Hamburg Model.....	173	Towel Forceps, Backhaus.....	136	Visual Axis Marker, Grene.....	45
Strabismus Hook, Jameson.....	174, S13, S15, S21, S23 -S24	Towel Forceps, Schaedel.....	136, S12, S19, S21, S23 -S24	Vitreoretinal Forceps.....	129 - 132, S21, S23 -S24
Strabismus Hook, Malbran.....	174, S18 -S19	Trabecular Aspiration Cannula.....	S12	Vitreoretinal Forceps 20 gauge.....	130, 131
Strabismus Marker.....	44	Trabecular Aspiration Cannula, Ph. Jacobi.....	S12	Vitreoretinal Forceps 23 gauge.....	132
Strabismus Marker, Fink.....	44	Trabecular Probe.....	186, S12	Vitreoretinal Forceps 25 gauge.....	132
Strabismus Muscle Tucker.....	42, 172, S18	Trabecular Probe, Harms.....	186, S12	Vitreoretinal Forceps, A. Mueller.....	130
Strabismus Muscle Tucker, Cueppers.....	42, 172, S18	Trabecular Probe, Mackensen.....	186	Vitreoretinal Forceps, Naito.....	130, 133
Strabismus Scissors.....	90 - 91, S15	Trabeculectomy Marker.....	44	Vitreoretinal Forceps, Reimann.....	129
Strabismus Scissors, Bonn Model.....	90	Trabeculectomy Marker, Fronimopoulos.....	44	Vitreoretinal Forceps, Tano.....	130, 132 - 133, S21, S23 -S24
Sub-Tenon Injection Cannula.....	193	Trabeculectomy Punch.....	76, S12	Vitreoretinal Scissors.....	95 - 96, S21, S23 -S24
Sub-Tenon Injection Cannula, Nagata.....	193	Trabeculectomy Punch, Luntz-Dodick.....	76, S12	Vitreoretinal Scissors 20 gauge.....	95
Superior Rectus Forceps.....	125 - 126, S2, S12, S19	Trabeculum Scissors.....	83		
Superior Rectus Forceps, Castroviejo.....	126	Trepphine.....	69 - 70, 215 - 216, 243, S7		
Superior Rectus Forceps, Elschmig.....	126	Trepphine, Best.....	69		
Superior Rectus Forceps, Leydhecker.....	126	Triangle Scleral Depressor.....	180		

KEYWORD PAGE

Vitreoretinal Scissors 23 gauge.....	96
Vitreoretinal Scissors 25 gauge.....	96
Vitreoretinal Scissors, Heimann.....	95-96,
.....S21, S23-S24	
Vitreoretinal Scissors, Kroll.....	95
Vitreoretinal Scissors, Naito.....	95
Vitreoretinal Scissors, Roider.....	95
Vitreous Cutter.....	222

W

Wire Loop.....	88
----------------	----

NAME PAGE

A

Agarwal..... 152
 Akahoshi..... 120-21, 154, S3
 Althaus / Cartsburg..... 202, S11
 American Model..... 38
 Amon..... 159
 A. Mueller..... 130
 Anel..... 189, S17
 Anis..... 160
 Arlt..... 161, S2, S4
 Arruga..... 144
 Auffarth..... 115, S3, S5
 Axenfeld..... 37, 52, S15-S17
 Ayer..... 134

B

Backhaus..... 136
 Bangerter..... 23, 107, 126, 166, 190,
S14, S18-S19
 Barraquer..... 15-19, 87, 101, 104, 109,
 139-141, 145, S2-S4, S9-S10, S12-S15, S19
 Barraquer Frankfurt Model..... 16
 Barraquer-Oosterhuis..... 18
 Barraquer-Troutman..... 140
 Bartl..... 22
 Bartz-Schmidt..... 175, S21
 Bauer..... 57
 Beer..... 101
 Behrens-Baumann..... 162
 Berke..... , 134
 Best..... 69
 Beyer..... 75
 Binkhorst..... 163, 194
 Blum..... 170, S7
 Bonn Model..... 63, 90, 92, 106, 110-111,
158, 172, 174, 190, 191, 194, S2-S4, S9,
S12-S13, S15, S19, S21, S23-S24
 Bopp..... 191, S10
 Bowman..... 185, S17
 Boynton..... 144
 Braunstein..... 43
 Brauweiler..... 85, 196, 198, 200, 201
 Bremen Model..... 156
 Breyer..... 169, 170, 171, S5, S8
 Bunge..... 52, S14
 Buratto..... 119, S7, S8
 Burk..... 193
 Busse..... 192

C

Castroviejo..... 23, 43, 81, 83, 103, 126, 142,
145, 163, 164, S2-S3, S9, S12-S19,
S21, S23-S24

NAME PAGE

Cauer..... 134
 Chang..... 210
 Chansue..... 169-170, S8
 Chayet..... 45, S7
 Cibis..... 245
 Citelli..... 75
 Cook..... 23-24, S13-S14
 Cranz..... 191, S3, S13
 Cueppers..... 42, 172, S18

D

Dardenne..... 65, 107, 157, S2
 D. D. Koch..... 159
 D.D. Koch - T. Kohnen..... 198, 199
 Desmarres..... 35-36, 134, S13-S16, S18
 Dick..... 26, 122, 169, 202, S5
 Dieffenbach..... 136, S2, S18-S19, S21, S23-S24
 Dithmar..... 66
 Doden..... 121, S2, S4
 Draeger..... 102, S16, S17-S18, S21, S23-S24
 Drysdale..... 155
 Duisburg Model..... 209, S21
 Duncker..... 42, S9

E

Elsa..... 243
 Elschnig..... 126, 164
 Elze..... 112
 Engels..... 44, 159
 Essen Model..... 127, 166

F

Fechner..... 121
 Fine..... 82, 149-150, S7-S8
 Fine-Thornton..... 149-150, S7-S8
 Fink..... 44, S18
 Flieringa..... 150, S9
 Foerster..... 65, 102
 Franceschetti..... 69
 Frankfurt Model..... 16, 156, 158, 165, 192,
225, S2, S12-S13
 Freiburg Model..... 102
 Friedmann..... 242, S17
 Fronimopoulos..... 44, S12

G

Gaskin..... 108, S4
 Gass..... 77
 Gerten..... 46, 117, S6, S11
 Giessen Model..... 36, 44, 167, 183, S17
 Goldstein..... 38
 Gradle..... 101

NAME PAGE

Graefe..... 93, 109, 173, S13-S14, S16, S18-S19
 Grehn..... 76, S12
 Greite..... 196
 Grene..... 45
 Guell..... 170
 Guthrie..... 38, S16

H

Haefliger..... 152
 Halstead..... 135, S2, S9, S12-S14,
S17-S19, S21, S23-S24
 Hamburg Model..... 63, 69, 101, 162,
173, 210, S19
 Hansen..... 65
 Harms..... 186, 245, S12
 Hartmann..... 135, S16, S21, S23, S24
 Hattenbach..... 86, 108, 117, 143, 149, 175,
180, 219, 221, 264, S4, S6, S21, S23
 Hattenbach / Nikolic..... 221, S23
 Hebra..... 52
 Heidelberg Model..... 109, 111, 144, 211, 242,
 S17
 Heimann..... 95-97, 128, S21, S23-S24
 Hennig / Friedrich..... 155
 Henry..... 101
 Hess-Engelking..... 112
 Hirschmann..... 157
 Hoffer..... 41
 Hoffmann..... 169, S5
 Homburg Model..... 48
 H.-R. Koch..... 17, 85, 88, 114-116, 124,
196, 200, S4
 Hunold..... 205

I

Ikeda..... 116, 116
 Inamura..... 115

J

Jacobi..... 156, 193, S9, S12
 Jaeger..... 36, S15, S16
 Jameson..... 174, S13, S15, S21, S23-S24
 Japan Model..... 85, 116, S5
 Juenemann..... 186, 190, 265, S17

K

Kalt..... 143
 Kammann..... 29
 Kampik..... 115, 207
 Katzin..... 81, S9, S10
 Kaufmann..... 102
 Keerl..... 198

NAME	PAGE	NAME	PAGE	NAME	PAGE
Kellnar.....	184	Meyhoefer.....	51, S15-S16	Schaedel.....	136, S12, S19, S21, S23-S24
Kelly.....	76, S12	Meyhoeffer.....	S15	Schioetz.....	48, S12
Kelman-McPherson.....	108, S8	Miyoshi.....	151	Schmack.....	198, 199
Kerrison.....	75, S17	Mohr.....	77	Schmidt-Mumm.....	69, S12
Kershner.....	25, S9, S14, S19, S21, S23-S24	Morcher.....	241, S4	Schocket.....	180, S15
Kilp.....	244, S21, S23-S24	Morris-Kroll.....	175	Schott.....	31, 32
Kirchhof.....	229	Mueller.....	38, 130, 194, S17	Scott.....	46, S6
Klein.....	208	Muenster Model.....	172, S17	Sekundo.....	123, 160
Klöckner.....	193	Munich Model.....	103	Shaaf.....	101, S13, S15
Knorz.....	26, 118, S7, S8	Murdock.....	24-25	Shepard.....	122
Koch-Kohnen.....	S3, S5	N		Simcoe.....	194, 226, S2
Koga / Noda.....	28	Nagahara.....	152-154, S3, S5	Sinskey.....	156, 171-172, S2-S4
Kohnen.....	154, 172, 198	Nagata.....	193	Snellen.....	161
Kratz.....	17-19, 195, 226, S2	Naito.....	95, 97, 130, 133	Snyder-Osher.....	88, 125, S4, S6
Kratz-Barraquer.....	17, 19	Noda.....	27, 28, 29	Solomon.....	26
Krefeld Model.....	102	Noyes.....	86	Spaleck.....	123
Kreissig.....	179	O		Spencer.....	92
Kroll.....	95, 97, 175	Ohno.....	17	Spirig.....	158, 161, 192
Krumeich.....	42, 186, 197, S10	Örk Linz Model.....	71	Steinmetz.....	87, 158, S4
Kuhn.....	246, S21	Osher.....	43, 86, 88, 125, S4, S6	Stevens.....	89, S3, S13-S14, S16-S19, S21, S23-S24
Kuhnt.....	64, S9, S14, S16	P		Strobel.....	125
Kyu.....	195	Papst.....	195, 205, 264	Swiss Model.....	111, 112
L		Paulfrique.....	64, 105, S9, S14, S21, S23-S24	Szurman.....	64, 71, 105, 117, 168, 203, 223, S11
Lambert.....	, S16, 134	Paulmann.....	27	T	
Landers.....	244	Peyman.....	244	Takeda.....	19
Laqua.....	179, 207, S19	Pfaeffl.....	118, 171, S7-S8	Tandogan.....	157
Lester.....	157	Pfaeffl-Breyer.....	171	Tano.....	130, 132-133, 219, S21, S23-S24
Lewicky.....	225	Pfennigwerth.....	127	Teping.....	195
Leyhecker.....	126	Ph. Jacobi.....	193, S12	Thomas Neuhann.....	19, 41-42, 70, 104, 112, 118, 151, 153-155, 167-168, 186, 202, S3, S5, S8-S11
Liebermann.....	25, 28, 154, S2-S3, S7-S8, S12	Plange.....	55, 56	Thornton.....	149-150, S7-S8
Liebermann-Tennant.....	25, 28, S2-S4, S7-S8, S10, S12-S13	Pretori.....	21	T. Kohnen.....	122, 154, 198
Lindstrom.....	42	R		T. Neuhann.....	123
Lohmann.....	243, S7, 64	Rau.....	168	Tobias Neuhann.....	44, 116-117, 152
Lordan.....	134, S16	Reimann.....	129	Tolentino.....	244
Lu.....	45, S7	Remky.....	105, 125, S2, S11-S12, S19	Troeltsch.....	127
Lucke.....	175, 179	Rentsch.....	156, 159-160, 194, S6, S10	Troutman.....	81, 140, 145, S2
Lund.....	158	R. Koch.....	201, 202	Tuebingen Model.....	84, 106, 192, 225, S2-S3, S10, S12-S13, S16-S19, S21, S23-S24
Luntz-Dodick.....	76, S12	Rohrschneider.....	144	V	
M		Roider.....	95, 210	Vannas.....	84-85, S2-S4, S9-S10, S13, S15, S21, S23-S24
Machemer.....	244	Rollet.....	37	Vogt.....	44, S18
Mackensen.....	82, 186	Rupal Shah.....	119, S8	Völcker.....	151
Mainz Model.....	155	Rycroft.....	225	von Barsewisch.....	121
Malbran.....	174, S18-S19	S		W	
Maloney.....	45, S9	Sattler.....	127, S18-S19	Walser.....	245, S14
Masket.....	113	Sauer.....	19		
Maus.....	30	Sautter.....	81, 162, 192, 225, S3-S5, S9, S12		
Mead.....	242, S17				
Mellinger.....	20				
Mellinger-Beard.....	20				
Mendez.....	45-46, S7				
Meyer-Schwickerath.....	180				

NAME PAGE

Watzke.....	127, S19
W. Bauer.....	196
Weber.....	161, 210, S21
Wecker.....	86, 87, 165
Weiss.....	21, 22
Wells.....	167, S14
West.....	243
Westcott.....	89, S2, S9, S12-S13, S16, S18-S19, S21, S23-S24
Wilder.....	183, S15, S17
Wright.....	243

Y

Yae.....	85, S5
Yörük.....	117

Z

Zirm.....	30, 151, 157, 167, 197, S7-S8
Zuerich Model.....	104



Geuder[®]
Precision made in Germany

GEUDER AG
Hertzstrasse 4
69126 Heidelberg
Germany

Phone: +49 6221 3066
Fax: +49 6221 303122
info@geuder.de
www.geuder.com